



## Tuš kadi

Tuš kade

Tuš kade

Zuhanytálcák

10

let garancije  
years warranty

7

let garancije  
years warranty



Zaštitni premaz  
Zaštitni premaz  
Zaštitni premaz  
Ápolókrém ek

> 307

### Poskrbite za zaščito vaše kopalnice!

Pobrinite se za zaščitu svoje kupaonice!  
Pobrinite se za zaščitu vašeg kupatila!  
Gondoskodjon fürdőszobája védelméről!



Dodatki za tuš kadi  
Dodaci za tuš kade  
Dodaci za tuš kade  
A zuhanytálcák kiegészítői

> 299

### Bi izdelek izpopolnili?

Želite li usavršiti proizvod?  
Da li bi želeli da usavršite proizvod?  
Tökéletesítené a terméket?





## Tuš kadi - preglednica po oblikah in dimenzijah

Tuš kade - pregled po oblicima i dimenzijama

Tuš kade - tabela po oblicima i dimenzijama

Zuhanykádak – áttekintés forma és dimenziók alapján

a x b	70	75	80		90			100		120	
180			Re-walk 126								
170		Flamenco 130	Flamenco 130								
160	Flamenco 130		Flamenco 130			Flamenco 130					
140	Flamenco 130		Re-walk 126			Bono 126					
130			Flamenco 130			Canary 128					
120	Flamenco 130		Flamenco 130			Flamenco 130					
110			Flamenco 130			Flamenco 130					
100			Flamenco 130			Flamenco 130					
90	Flamenco 130	Canary 128	Flamenco 130			Flamenco 130					
80			Boston 134	Ontex 139							
70	Flamenco 130		Rock 132	Pony 138							

INFO



a x b

dimenzije v cm:



oblika: / oblik: / oblik: / forma:

dimenzije u cm:



klasična, klasični, klasični, hagyományos

dimenzije u cm:



polkrožna, polukružni, polukružni, félköríves

dimenziók cm-ben:



asimmetrična, asimmetrični, asimmetričan, asszimetrikus

material: / materijal: / materijal: / anyag:



liti sanitarni akril, lijevani sanitarni akril, liveni sanitarni akril, öntött szaniterakril



kerrock, kerrock, kerrock, kerrock



liti marmor, lijevani mramor, liveni mermer, öntött márvány

000

stran / stranica / strana / apród:

## Tuš kadi

Tuš kade  
Tuš kade  
Zuhanytálcák



MILOTRAY 120x120 013

Premium



BOULTRAY 120x120 015

Premium

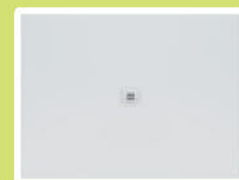

HORA STONE 120x90, 120x80, 100x80 124



HORATILE STONE 100x100, 90x90 125

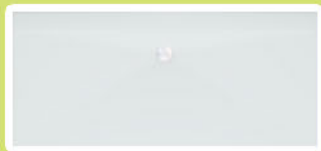

RE-WALK 180x80, 140x80 126



BONO 140x90 126



VIP 120x90 127

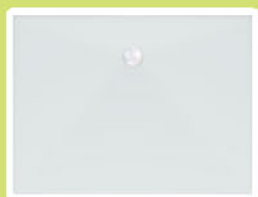

VALS 120x90, 120x80 127



CANARY 140x90, 120x90, 120x80,  
100x100, 100x80, 90x90, 90x75 128



MACARENA 100x100, 90x90 128

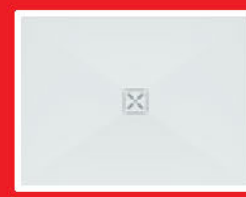

LEROCK ZERO 120x90, 120x80, 100x100, 90x90 129



FLAMENCO 180x80, 170x80, 170x75,  
160x90, 160x80, 160x70, 140x90, 140x80,  
140x70, 130x90, 130x80, 120x90, 120x80,  
120x70, 110x90, 110x80, 100x90, 100x80,  
90x90, 90x80, 90x70, 70x70 130

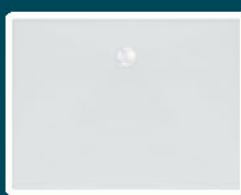

SALSA 140x90, 120x90,  
120x80, 100x100, 90x90 131

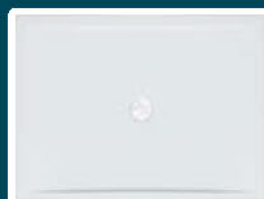

HAKA 120x90, 120x80 131



ROCK 100x100, 90x90, 80x80 132

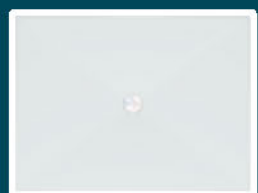

STEP ZERO 120x90,  
120x80, 100x100, 90x90 133

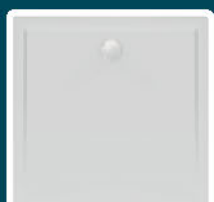

BOSTON 100x100, 90x90, 80x80 134



HORON 90x90 134



TRIN 90x90, 80x80 135



MALUR-L 120x90, 100x80 136



MALUR-D 120x90, 100x80 136



EISA 90x90 137



BLUES 100x100, 90x90 137



PONY 90x90, 80x80 138



DIXIE 90x90 138



BEBOP 90x90 139



ONTEX 90x90, 80x80 139

INFO





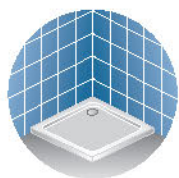
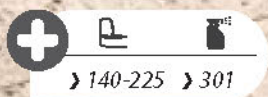

### Hora stone 120, 100

- tuš kad iz litega marmorja, s plitvim dnom. Reliefna protizdrsna površina.
- tuš kada od lijevanog mramora, s plitkim dnom. Reljefna protuklizna površina.
- tuš kada od livenog mramora, sa plitkim dnom. Reljefna protuklizna površina.
- zuhanytálca öntött márványból, sekély fenékkal. Reliefes csúszásgátló felület.



white

manhattan

antracit

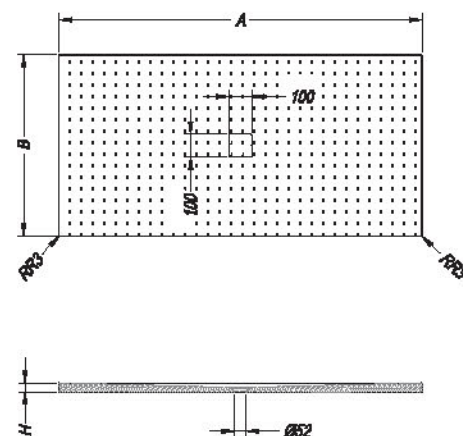

	A	B	C	H	VM
Hora stone 120 x 90	1200	900	15	35	35
Hora stone 120 x 80	1200	800	15	35	35
Hora stone 100 x 80	1000	800	15	35	35

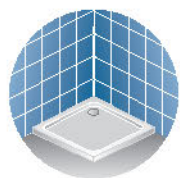

### Hora tile stone 100, 90

- tuš kad iz litega marmorja, s plitvim dnom. Reliefna protizdrsna površina.
- tuš kada od lijevanog mramora, s plitkim dnom. Reliefna protuklizna površina.
- tuš kada od livenog mermera, sa plitkim dnom. Reliefna protivklizna površina.
- zuhanytálca öntött márványból, sekély fenékkal. Reliefes csúszásgátló felület.

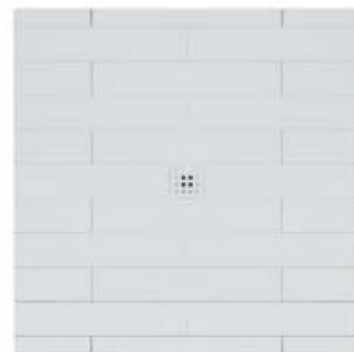

HORA TILE STONE



white

manhattan

antracit

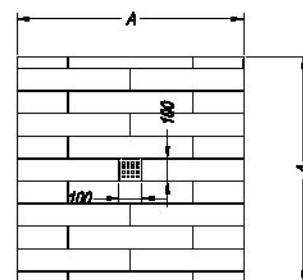
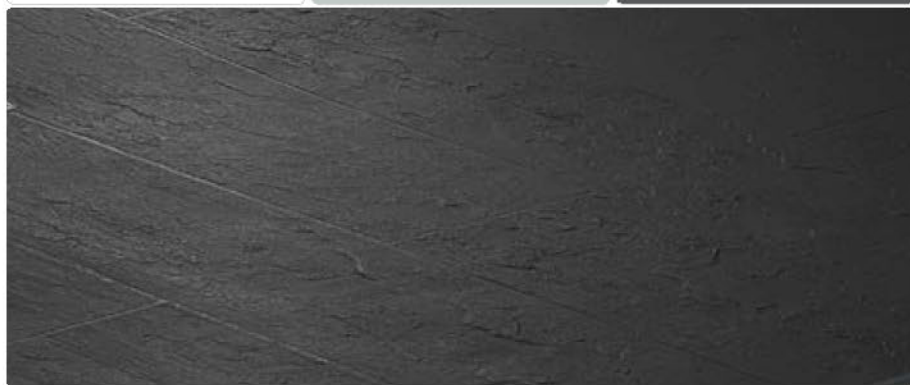

	A	B	C	H	VM
Hora tile stone 100 x 100	1000	1000	15	35	35
Hora tile stone 90 x 90	900	900	15	35	35



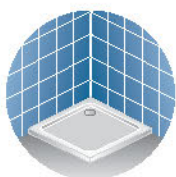
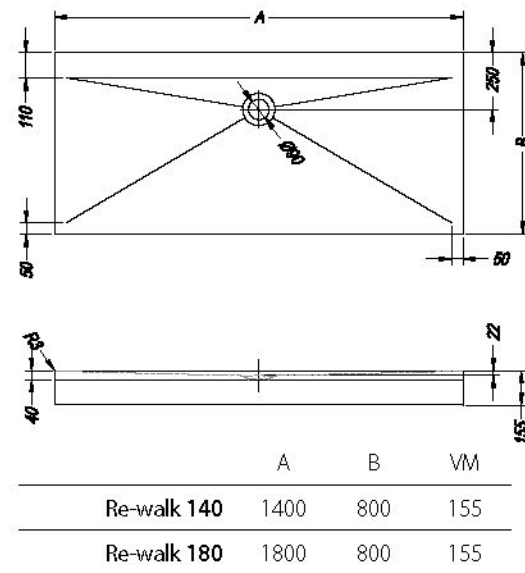
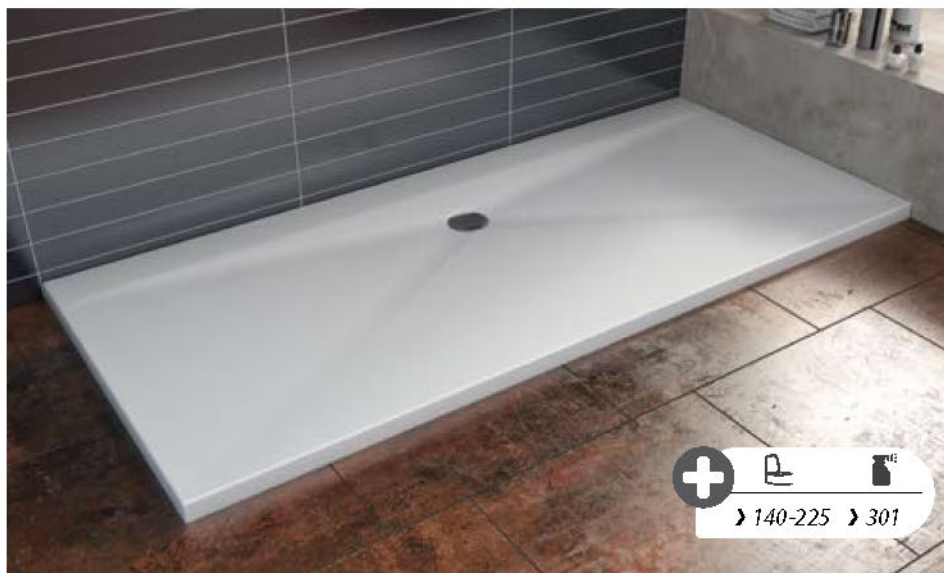

#### Re-walk 180x80

- tuš kad iz litega marmorja, s plitvim dnom, možnost prirezovanja levo, desno in zadaj do dimenzije 140x70 cm
- tuš kada od lijevanog mramora s plitkim dnom, mogućnost rezanja lijevo, desno i straga do dimenzije 140x70 cm
- tuš kada od livenog mermerna, sa plitkim dnom, mogućnost skraćivanja levo, desno i pozadi do dimenzije 140x70 cm
- öntött márvány zuhanykád, sekély aljjal, méretre szabható balra és jobbra is 140x70 cm méretig

#### Re-walk 140x80

- tuš kad iz litega marmorja, s plitvim dnom, možnost prirezovanja levo in desno in zdaj do dimenzije 110x70 cm
- tuš kada od lijevanog mramora s plitkim dnom, mogućnost rezanja lijevo, desno i straga do dimenzije 110x70 cm
- tuš kada od livenog mermerna, sa plitkim dnom, mogućnost skraćivanja levo, desno i pozadi do dimenzije 110x70 cm
- öntött márvány zuhanykád, sekély aljjal, méretre szabható balra és jobbra is 110x70 cm méretig

**marmosan®**

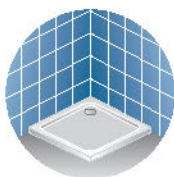
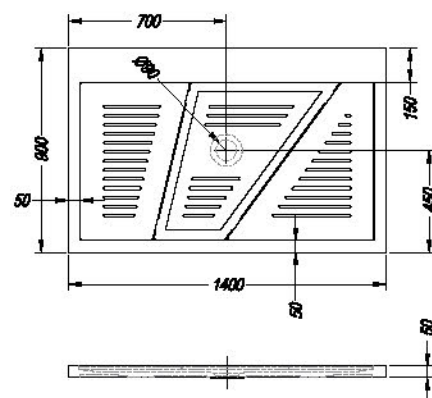

#### Bono 140

- tuš kad iz litega marmorja, s plitvim dnom.
- tuš kada od lijevanog mramora, s plitkim dnom.
- tuš kada od livenog mermerna, sa plitkim dnom.
- zuhanytálca öntött márványból, sekély fenékkal.

**marmosan®**



white 10

rhyolite 5194

stardust 9017

graphite 9070

diaspore M 1060

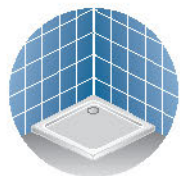

### Vip 120

- tuš kad iz litega marmorja, s plitvim dnom.
- tuš kada od lijevanog mramora, s plitkim dnom.
- tuš kada od livenog mermera, sa plitkim dnom.
- zuhanytálca öntött márványból, sekély fenékkal.



### Vip 120/O

- tuš kad z oblogo.
- kada za tuširanje s oblogom.
- tuš kada sa oblogom.
- zuhanytálca előlappal.

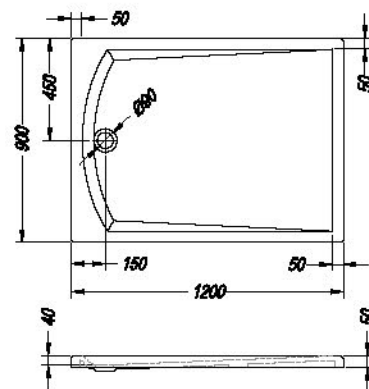

	A	B	VM
Vip 120 x 90	1200	900	165

	A	B	VM
Vals 120 x 90	1200	900	155
Vals 120 x 80	1200	800	155

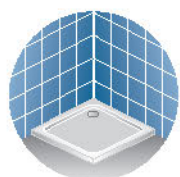
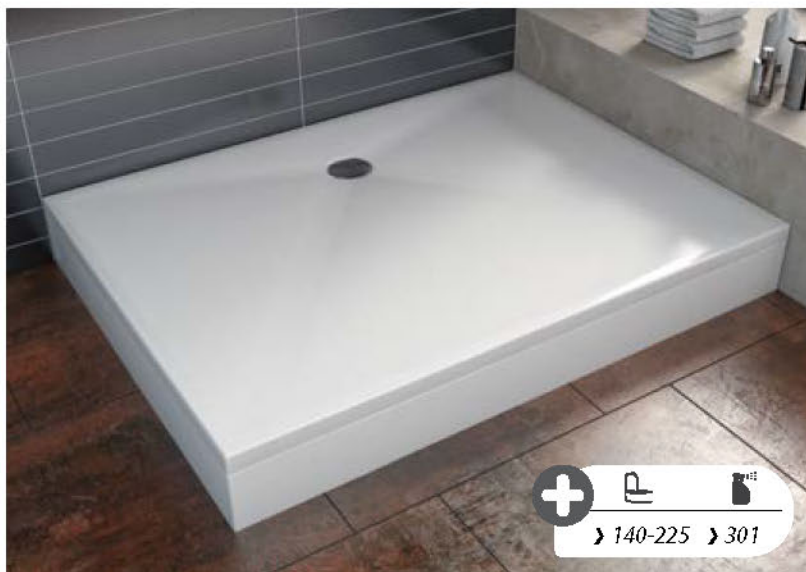

### Vals 120

- tuš kad iz litega marmorja, s plitvim dnom.
- tuš kada od lijevanog mramora, s plitkim dnom.
- tuš kada od livenog mermera, sa plitkim dnom.
- zuhanytálca öntött márványból, sekély fenékkal.



### Vals 120/O

- tuš kad z oblogo.
- kada za tuširanje s oblogom.
- tuš kada sa oblogom.
- zuhanytálca előlappal.

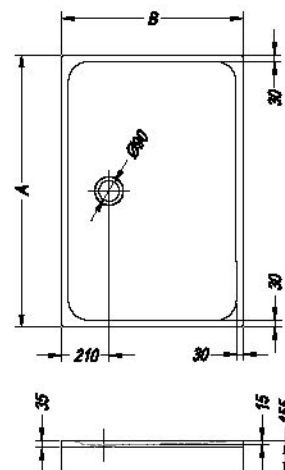

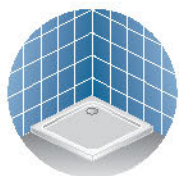
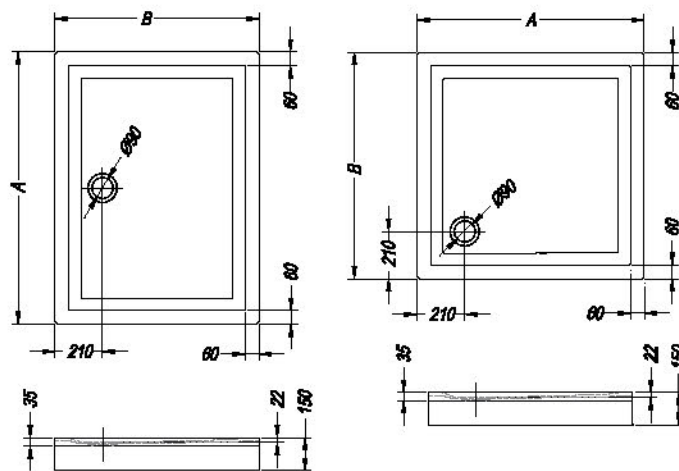

### Canary 140, 120, 100, 90

- tuš kad iz litega marmorja, s plitkim dnom.
- tuš kada od lijevanog mramora, s plitkim dnom.
- tuš kada od livenog mermera, sa plitkim dnom.
- zuhanytálca öntött márványból, sekély fenékkal.

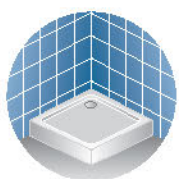

### Canary 140/O, 120/O, 100/O, 90/O

- tuš kad z oblogo.
- kada za tuširanje s oblogom.
- tuš kada sa oblogom.
- zuhanytálca előlappal.



	A	B	VM
Canary 140 x 90	1400	900	150
Canary 120 x 90	1200	900	150
Canary 120 x 80	1200	800	150
Canary 100 x 100	1000	1000	150
Canary 100 x 80	1000	800	150
Canary 90 x 90	900	900	150
Canary 90 x 75	900	750	150



	A	B	VM
Macarena 100 x 100	1000	1000	150
Macarena 90 x 90	900	900	150



### Macarena 100, 90

- tuš kad, vgradna, s plitkim dnom.
- ugradbena kada za tuširanje, s plitkim dnom.
- ugradna tuš kada, sa plitkim dnom.
- beépíthető zuhanytálca, sekély fenékkal.



### Macarena 100/O, 90/O

- tuš kad z oblogo.
- kada za tuširanje s oblogom.
- tuš kada sa oblogom.
- zuhanytálca előlappal.

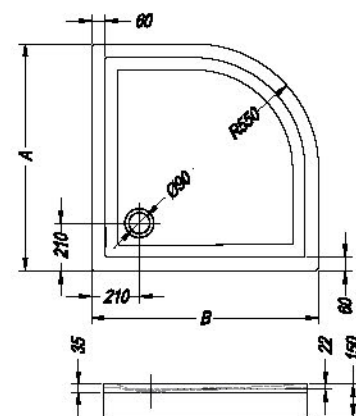



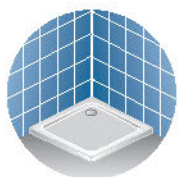

### Lerock ZERO 120, 100

- tuš kad iz Kerrocka, s plitkim dnom, za vgradnju z nivijem tal, visoko-pretočni sifon Ø 52, nosilna konstrukcija, H =12mm.
- tuš kada od Kerrocka, s plitkim dnom, za ugradnju u razini poda, visokoprotočni sifon Ø 52, nosiva konstrukcija, H =12mm.
- tuš kada od Kerrocka, sa plitkim dnom, sa ugradnju u nivou poda, visokoprotočni sifon Ø 52, noseća konstrukcija, H =12mm.
- zuhanytálca Kerrocka, sekély fenékkal, padlószintbe beépíthető, magas átfolyású szifon Ø 52, tartószerkezet, H =12mm.

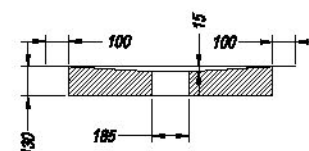
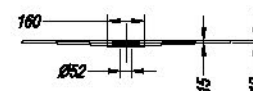
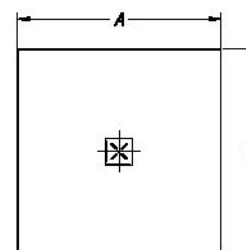
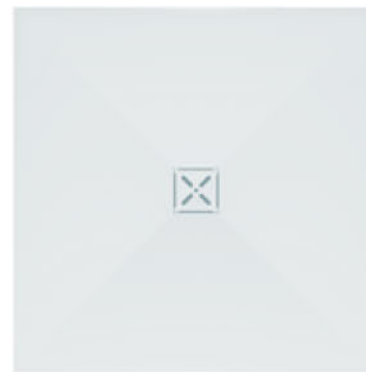

Vgradnja v nivouju tal, z možnostíjo kompenzacije višine do max 15 cm.  
 Ugradnja u razini poda s mogućnošću kompenzacije visine do maks. 15 cm.  
 Ugradnja u nivouu poda, sa mogućnošću kompenzacije visine do maks. 15 cm.  
 Ugradnja v nivouju tal, z možnostíjo kompenzacije višine do max 15 cm.

- 1 - tuš kad / tuš kada / tuš kada / zuhanykád
- 2 - sanitarni silikon / sanitarni silikon / sanitarni silikon / szanitér szilikon
- 3 - keramika / keramika / keramika / csempe
- 4 - water stop folija / water stop folija / water stop folija / water stop fólia
- 5 - stiropor / stiropor / stiropor / sztiropor
- 6 - mapelastíc / mapelastíc / mapelastíc / mapelastíc

	A	B	VM
Lerock zero 120 x 90	1200	900	0
Lerock zero 120 x 80	1200	800	0
Lerock zero 100 x 100	1000	1000	0
Lerock zero 90 x 90	900	900	0

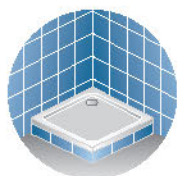
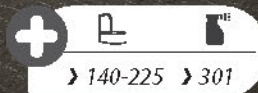

#### Flamenco 180, 170, 160, 140, 130, 120, 110, 100, 90, 70

- tuš kad, vgradna, s plitkim dnom.
- ugradbena kada za tuširanje, s plitkim dnom.
- ugradna tuš kada, sa plitkim dnom.
- beépíthető zuhanytálca, sekély fenékkal.



#### Flamenco 180/O, 170/O, 160/O, 140/O, 130/O, 120/O, 110/O, 100/O, 90/O, 70/O

- tuš kad z oblogo.
- kada za tuširanje s oblogom.
- tuš kada sa oblogom.
- zuhanytálca előlappal.

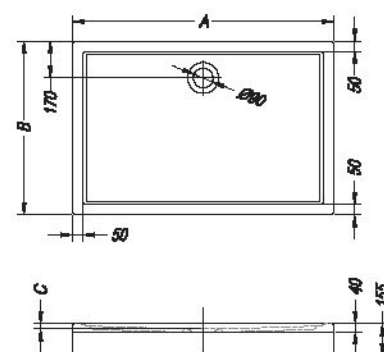

	A	B	C	VM
Flamenco 180 x 80	1800	800	35	155
Flamenco 170 x 80	1700	800	35	155
Flamenco 170 x 75	1700	750	30	155
Flamenco 160 x 90 (80)	1600	900 (800)	35	155
Flamenco 160 x 70	1600	700	30	155
Flamenco 140 x 90 (80 / 70)	1400	900 (800 / 700)	25	155
Flamenco 130 x 90 (80)	1300	900 (800)	25	155
Flamenco 120 x 90 (80)	1200	900 (800)	25	155
Flamenco 120 x 70	1200	700	25	155
Flamenco 110 x 90 (80)	1100	900 (800)	25	155
Flamenco 100 x 100	1000	1000	25	155
Flamenco 100 x 90 (80)	1000	900 (800)	25	155
Flamenco 90 x 90 (70)	900	900 (700)	25	155
Flamenco 90 x 80	900	800	25	155
Flamenco 70 x 70	700	700	25	155





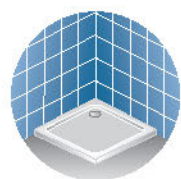
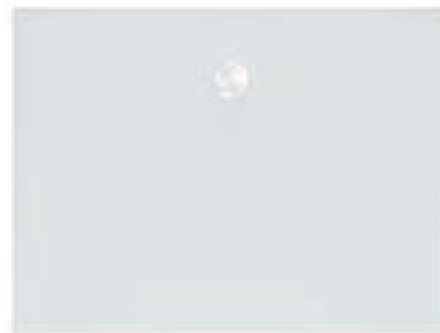
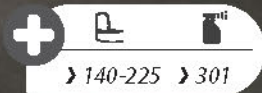

### Salsa 160, 140, 120, 100, 90

- tuš kad, vgradna, s plitvim dnom.
- ugradbena kada za tuširanje, s plitkim dnom.
- ugradna tuš kada, sa plitkim dnom.
- beépíthető zuhanytálca, sekély fenékkal.



### Salsa 160/O, 140/O, 120/O, 100/O, 90/O

- tuš kad z oblogo.
- kada za tuširanje s oblogom.
- tuš kada sa oblogom.
- zuhanytálca előlappal.

	A	B	VM
Salsa 140 x 90	1400	900	140
Salsa 120 x 90	1200	900	140
Salsa 120 x 80	1200	800	140
Salsa 100 x 100	1000	1000	140
Salsa 90 x 90	900	900	140

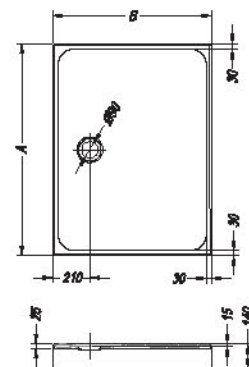

	A	B	VM
Haka 120 x 90	1200	900	155
Haka 120 x 80	1200	800	155

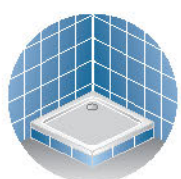

### Haka 120 x 90, 120 x 80

- tuš kad, vgradna, s plitvim dnom.
- ugradbena kada za tuširanje, s plitkim dnom.
- ugradna tuš kada, sa plitkim dnom.
- beépíthető zuhanytálca, sekély fenékkal.

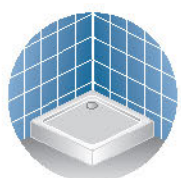

### Haka 120 x 90/O, 120 x 80/O

- tuš kad z oblogo.
- kada za tuširanje s oblogom.
- tuš kada sa oblogom.
- zuhanytálca előlappal.

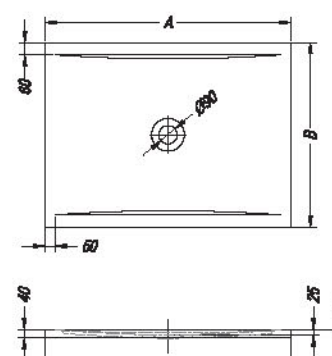



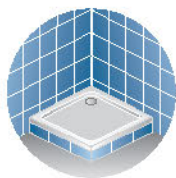
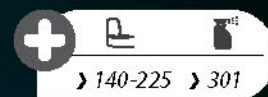

#### Rock 100, 90, 80

- tuš kad, vgradna.
- ugradbena kada za tuširanje.
- ugradna tuš kada.
- beépíthető zuhanytálca.



#### Rock 100/O, 90/O, 80/O

- tuš kad z oblogo.
- kada za tuširanje s oblogom.
- tuš kada sa oblogom.
- zuhanytálca háromrétegű előlappal.

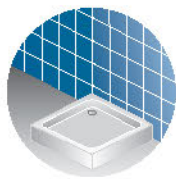

#### Rock 90/30, 80/30

- tuš kad s tristransko oblogo.
- kada za tuširanje sa tristranom oblogom.
- tuš kada sa trostranom oblogom.
- zuhanytálca háromrétegű bevonattal.

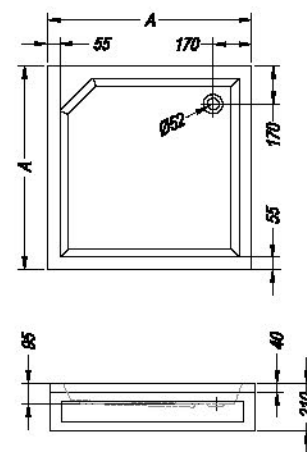

	A	
Rock 100 x 100	1000	
Rock 90 x 90	900	210
Rock 80 x 80	800	210

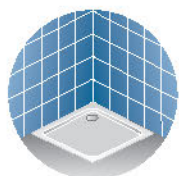

### Step ZERO 120, 100, 90

- tuš kad iz sanitarnega litega akrila, s plitvim dnom, za vgradnjo z nivojem tal, visoko-pretočni sifon  $\varnothing 90$ , nosilna konstrukcija, H = 15 mm.
- tuš kada od sanitarnog lijevanog akrila, s plitkim dnom, za ugradnju u razini poda, visokoprotlačni sifon  $\varnothing 90$ , nosiva konstrukcija, H = 15 mm.
- tuš kada od sanitarnog livenog akrila, sa plitkim dnom, sa ugradnju u nivou poda, visokoprotlačni sifon  $\varnothing 90$ , noseća konstrukcija, H = 15 mm.
- zuhanytálca szaniter öntött akril, sekély fenékkal, padlószintbe beépíthető, magas átfolyású szifon  $\varnothing 90$ , tartószerkezet, H = 15 mm.

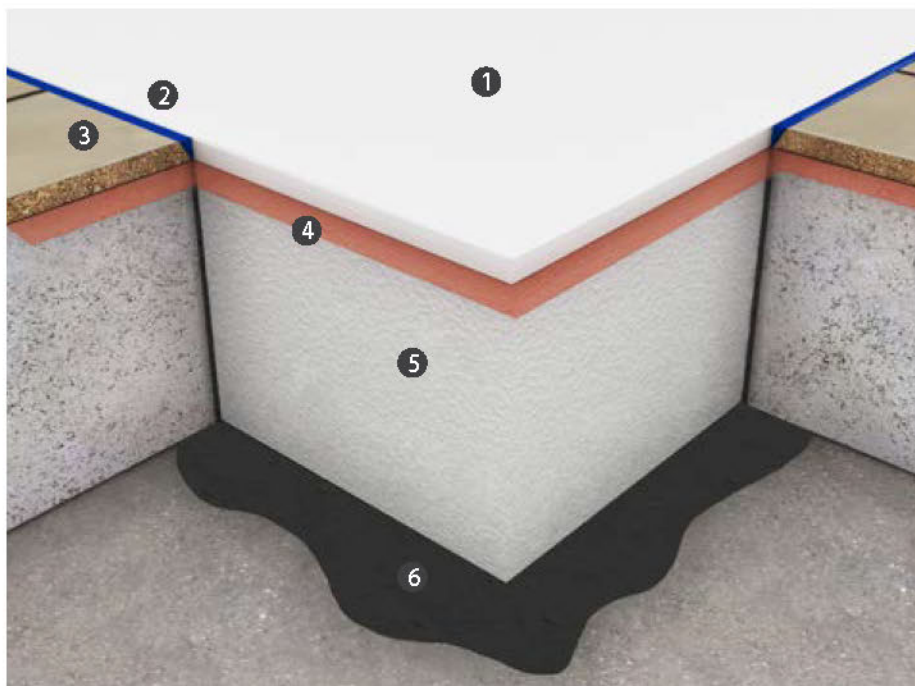
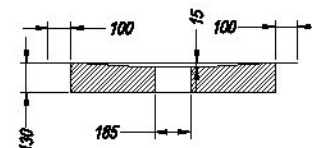
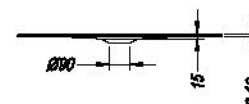
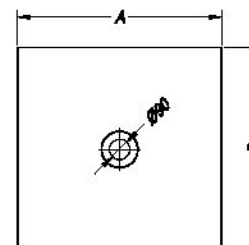
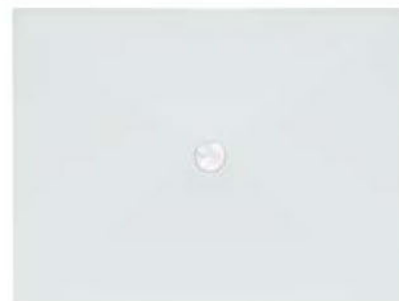

Vgradnja v nivoju tal, z možnostjo kompenzacije višine do max 15 cm.  
 Ugradnja u razini poda s mogućnošću kompenzacije visine do maks. 15 cm.  
 Ugradnja u nivou poda, sa mogućnošću kompenzacije visine do maks. 15 cm.  
 Ugradnja v nivoju tal, z možnostjo kompenzacije višine do max 15 cm.

- 1 - tuš kad / tuš kada / tuš kada / zuhanykád
- 2 - sanitarni silikon / sanitarni silikon / sanitarni silikon / szanitér szilikon
- 3 - keramika / keramika / keramika / csempe
- 4 - water stop folija / water stop folija / water stop folija / water stop fólia
- 5 - stiropor / stiropor / stiropor / sztiropor
- 6 - mapelastik / mapelastik / mapelastik / mapelastik

	A	B	VM
Step zero 120 x 90	1200	900	0
Step zero 120 x 80	1200	800	0
Step zero 100 x 100	1000	1000	0
Step zero 90 x 90	900	900	0

Izdelek je zelo primeren za starejše uporabnike.  
 Proizvod je vrlo primjeren za starije korisnike.  
 Proizvod je veoma adekvatan za starije korisnike.  
 A termék megfelel az idősebb felhasználók igényeinek.

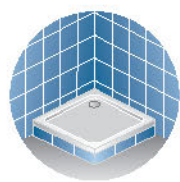
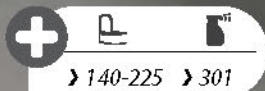

### Boston 100, 90, 80

- tuš kad, vgradna.
- ugradbena kada za tuširanje.
- ugradna tuš kada.
- beépíthető zuhanytálca.

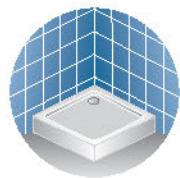

### Boston 100/O, 90/O, 80/O

- tuš kad z oblogo.
- kada za tuširanje s oblogom.
- tuš kada sa oblogom.
- zuhanytálca előlappal.

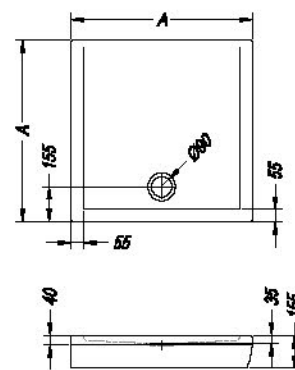

	A	VM
Boston 100 x 100	1000	155
Boston 90 x 90	900	155
Boston 80 x 80	800	155



Izdelek je zelo primeren za starejše uporabnike.  
Proizvod je vrlo primjeren za starije korisnike.  
Proizvod je veoma adekvatan za starije korisnike  
A termék megfelel az idősebb felhasználók igényeinek.

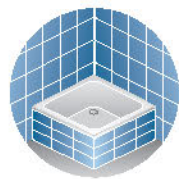

### Horon 90

- tuš kad, vgradna, globina 30 cm.
- ugradbena kada za tuširanje, dubina 30 cm.
- ugradna tuš kada, dubina 30 cm.
- beépíthető zuhanytálca, 30 cm mély.



- sedež
- sjedalo
- sedište
- ülés

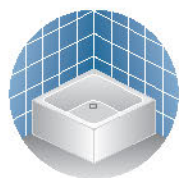
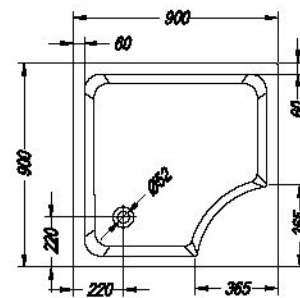

### Horon 90/O

- tuš kad z oblogo, globina 30 cm.
- Možnost vgradnje tuš kabine, h = 160 cm.
- kada za tuširanje s oblogom, dubina 30 cm.
- Mogućnost ugradnje tuš kabine, h = 160 cm.
- tuš kada sa oblogom, dubina 30 cm.
- Mogućnost ugradnje tuš kabine, h = 160 cm.
- zuhanytálca előlappal, 30 cm mély.
- Beépíthető zuhanykabin, h = 160 cm.

	A	B	VM
Horon 90 x 90	900	900	415

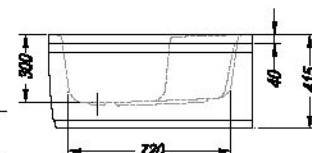



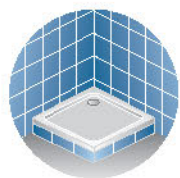

#### Trin 90, 80

- tuš kad, vgradna.
- ugradbena kada za tuširanje.
- ugradna tuš kada.
- beépíthető zuhanytálca.

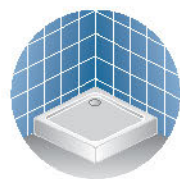

#### Trin 90/O, 80/O

- tuš kad z oblogo.
- kada za tuširanje s oblogom.
- tuš kada sa oblogom.
- zuhanytálca előlappal.



TRIN 90, 80



**Dodatki za kopalne kadi**  
Dodaci kupaoškim kadama  
Dodaci za kade  
A fürdőkádák kiegészítói

› 298

#### **Bi izdelek izpopolnili?**

Želite li usavršiti proizvod?  
Da li bi želeli da usavršite proizvod?  
Tökéletesítené a terméket?



	A	VM
Trin 90 x 90	900	170
Trin 80 x 80	800	170

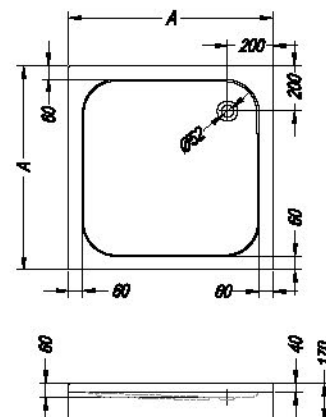



**Malur 120x90, 100x80**

- tuš kad, vgradna.
- ugradbena kada za tuširanje.
- ugradna tuš kada.
- beépíthető zuhanytálca.



Malur 120,100 - L



Malur 120,100 - D



**Malur 120x90/O, 100x80/O**

- tuš kad z oblogom.
- kada za tuširanje s oblogom.
- tuš kada sa oblogom.
- zuhanytálca előlappal.

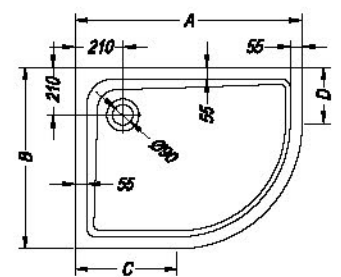
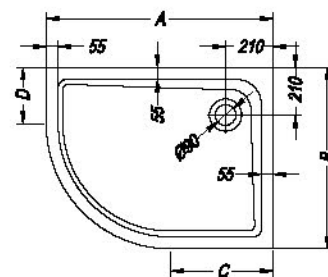

	A	B	C	D	VM
Malur 120 x 90	1200	900	650	350	155
Malur 100 x 80	1000	800	450	250	155

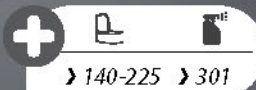

### Eisa 90

- tuš kad, vgradna, s plitkim dnom.
- ugradbena kada za tuširanje, s plitkim dnom.
- ugradna tuš kada, sa plitkim dnom.
- beépíthető zuhanytálca, sekély fenékkal.



### Eisa 90/O

- tuš kad z oblogo.
- kada za tuširanje s oblogom.
- tuš kada sa oblogom.
- zuhanytálca előlappal.

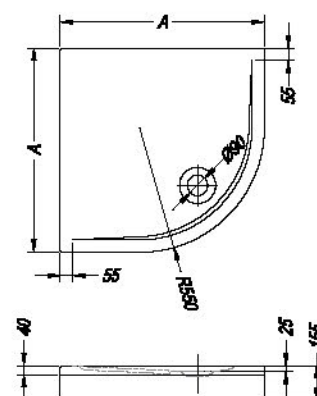

	A	VM
Eisa 90 x 90	900	155

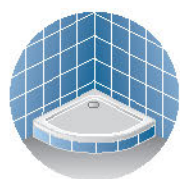

### Blues 100,90

- tuš kad, vgradna.
- ugradbena kada za tuširanje.
- ugradna tuš kada.
- beépíthető zuhanytálca.



### Blues 90/30

- tuš kad s tristransko oblogo.
- kada za tuširanje sa tristranom oblogom.
- tuš kada sa trostranom oblogom.
- zuhanytálca háromrétégű bevonattal.

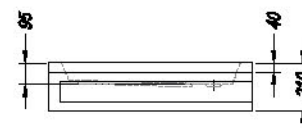
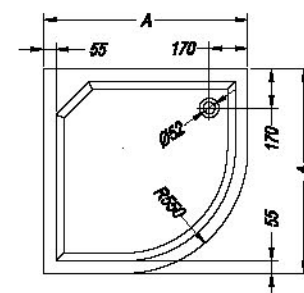

	A	VM
Blues 100 x 100	1000	210
Blues 90 x 90	900	210





	A	VM
<b>Pony 90 x 90</b>	900	155
<b>Pony 80 x 80</b>	800	155



### Pony 90, 80

- tuš kad, vgradna.
- ugradbena kada za tuširanje.
- ugradna tuš kada.
- beépíthető zuhanytálca.



### Pony 90/O, 80/O

- tuš kad z oblogo.
- kada za tuširanje s oblogom.
- tuš kada sa oblogom.
- zuhanytálca előlappal.

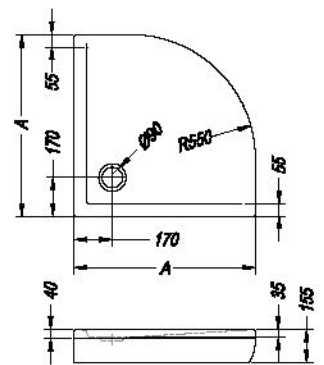

Izdelek je zelo primeren za starejše uporabnike.  
Proizvod je vrlo primjeren za starije korisnike.  
Proizvod je veoma adekvatan za starije korisnike  
A termék megfelel az idősebb felhasználók igényeinek.



### Dixie 90

- tuš kad, vgradna, globina 30 cm.
- ugradbena kada za tuširanje, dubina 30 cm.
- ugradna tuš kada, dubina 30 cm.
- beépíthető zuhanytálca, 30 cm mély.



### Dixie 90/O

- tuš kad z oblogo, globina 30 cm.
- Možnost vgradnje tuš kabine, h = 160 cm.
- kada za tuširanje s oblogom, dubina 30 cm.
- Mogućnost ugradnje tuš kabine, h = 160 cm.
- tuš kada sa oblogom, dubina 30 cm.
- Mogućnost ugradnje tuš kabine, h = 160 cm.
- zuhanytálca előlappal, 30 cm mély.
- Zuhanykabin beépíthető, h = 160 cm.

- sedež
- sjedalo
- sedište
- ülés

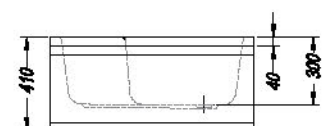
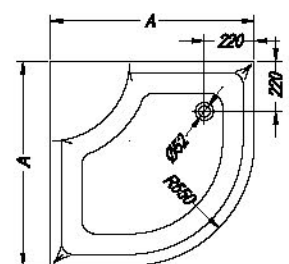

	A	VM
<b>Dixie 90 x 90</b>	900	410

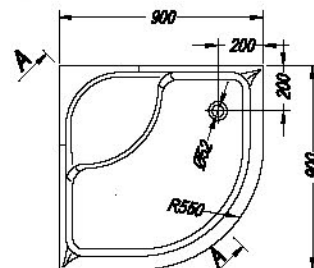

### Bebop 90

- tuš kad, vgradna.
- ugradbena kada za tuširanje.
- ugradna tuš kada.
- beépíthető zuhanytálca.



- sedež
- sjedalo
- sedište
- ülés



### Bebop 90/O

- tuš kad z oblogo.
- kada za tuširanje s oblogom.
- tuš kada sa oblogom.
- zuhanytálca előlappal.

Izdelek je zelo primeren za starejše uporabnike.  
Proizvod je vrlo primjeren za starije korisnike.  
Proizvod je veoma adekvatan za starije korisnike.  
A termék megfelel az idősebb felhasználók igényeinek.

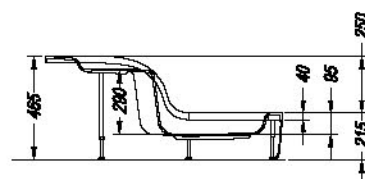

	A	VM
Bebop 90 x 90	900	215



### Ontex 90, 80

- tuš kad, vgradna.
- ugradbena kada za tuširanje.
- ugradna tuš kada.
- beépíthető zuhanytálca.



### Ontex 90/O, 80/O

- tuš kad z oblogo.
- kada za tuširanje s oblogom.
- tuš kada sa oblogom.
- zuhanytálca előlappal.

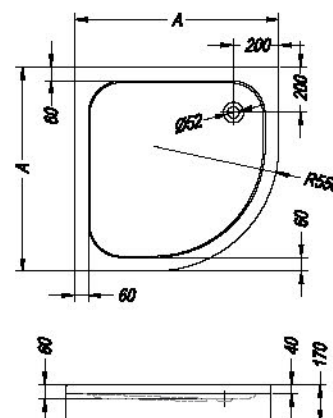

	A	VM
Ontex 90 x 90	900	170
Ontex 80 x 80	800	170