



Tuš kabine

Tuš kabine

Tuš kabine

Zuhanykabinok

3

leta garancije
years warranty



Mast za ležaje tuš kabin
Mast za ležajeve tuš kabina
Mast za ležajeve tuš kabina
Zuhanycsapágy kenőzsír

> 301

Poskrbite, da bo vse teklo tiho in gladko!

Pobrinite se da sve teče tiho i gladko!
Pobrinite se da sve ide tiho i gladko!
Gondoskodjon, hogy minden csendesen, simán folyjon!



Tuš kabine posebnih dimenzij
Tuš kabine posebnih dimenzija
Tuš kabine specijalnih dimenzija
Különleges méretű zuhanyfülkék

> 147

Potrebujete rešitev po meri?

Trebate rješenje po mjeri?
Treba vam rešenje po mjeri?
Méretre szabott megoldásra van szüksége?





SQ line

› 184



6/5 mm 6/5 mm 190 cm 190 cm



Luna

› 192



6/4 mm 6/4 mm 185 cm



Eco Quat

› 198



5 mm 185 cm



Orion

› 202



6 mm 6 mm 140 cm



Sole

› 208

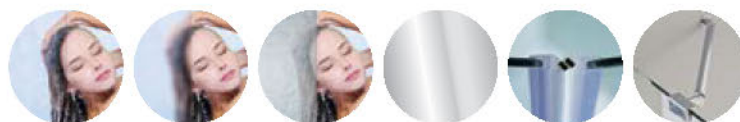

6 mm 6 mm 6 mm 140 cm



Quat

› 220



5 mm 2 mm 140 cm





Tuš kabine - preglednica po oblikah in postavitvah

Tuš kabine - pregled po oblicima i dimenzijama

Tuš kabine - tabela po oblicima i postavljanjima

Zuhanykádak - áttekintés forma és kivitelezés alapján

Postavitev / Postavljanje / Postavljanje / Kivitelezés

program program program program									
Terra	TKK	TKP	TV+TSv			TV/S			
Terra Flat	TKK					TV/S			
Atlas	TKK	TKP	TV+TSv			TV/S			
Corona	TS OPEN	TS OPEN + TS					TK OPEN	TK OPEN + TS	PS
Virgo NEW	TK					TV2D/S			
Kronos NEW	TK					TV2D/S			
Pulsar	TKK	TKP							
SQ line	TKK	TKP	TV2D/S + TS	TV4D/S + TS	TKP DIXIE	TV2D/S	TV4D/S		
Luna	TV3D/S + TSv	TVZ/S + TSvZ				TV3D/S	TVZ/S	TV0/S	
Eco Quat	TKK	TKP							
Orion									
Sole									
Quat									

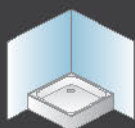

kotna postavitev
kutno postavljanje
ugaono postavljanje
sarkos kivitelezés



postavitev v niši
postavljanje u niši
postavljanje u niši
kivitelezés fülkében

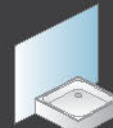

postavitev ob steni
postavljanje uz zid
postavljanje uz zid
falmelletti kivitelezés



Poiščite tuš kabino, ki vam ustreza, na naslednji strani pa poiščite, kje se v katalogu nahaja.
 Potražite tuš kabinu koja vam odgovara, a na sljedećoj stranici potražite gdje se nalazi u katalogu.
 Potražite tuš kabinu koja vam odgovara, a na sljedećoj stranici potražite gdje se nalazi u katalogu.
 Keresse meg a megfelelő zuhanykabinát, majd a következő oldalán keresse meg, hol található meg a katalógusban.

> 140 - 225

Postavitev / Postavljanje / Postavljanje / Kivitelezés

program program program program										
Terra										
Terra Flat										
Atlas										
Corona										
Virgo NEW										
Kronos NEW										
Pulsar										
Q line										
Luna										
Eco Quat										
Orion										
Sole										
Quat										

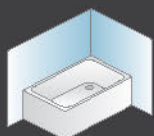

kotna postavitev
 kutno postavljanje
 ugaono postavljanje
 sarkos kivitelezés

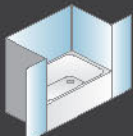

postavitev v niši
 postavljanje u niši
 postavljanje u niši
 kivitelezés fülkében





Dodatni profili pri tuš kabinah

Dodatni profili za tuš kabine

Dodatní profílí kod tuš kabína

Kiegészítő profilok zuhanykabinokhoz



Imam nestandardne dimenzije kopalnice, kaj pa zdaj?

Imam nestandardne dimenzije kupaonice, što sada?

Imam nestandardne dimenzije kupatila, šta da radim?

Szokatlan fürdőszobaméretekkel rendelkezem. Mi teendő legyek?

Za primere, ko prostor na razpolago za vgradnjo tuš kabin ni standardnih dimenzij, smo razvili dodatne kompenzacijske profile, s katerimi lahko prilagodimo standardne izdelke na željeno mero. Na naslednjih straneh lahko preverite, kateri izdelki ponujajo to možnost.

Za slučajeve kada prostor na raspolaganje za ugradnju tuš kabina nije standardnih dimenzija razvili smo dodatne kompenzacijske profile s kojima možemo prilagoditi standardne proizvode prema željenoj mjeri. Na sljedećim stranicama možete provjeriti proizvodi pružaju tu mogućnost.

Za slučajeve, kad prostor za ugradnju tuš kabina nije standardnih dimenzija, razvili smo dodatne kompenzacione profile pomoću kojih možemo da prilagodimo standardne proizvode na željenu meru. Na sledećim stranicama možete da proverite koji proizvodi pružaju tu mogućnost.

Azokra az esetekre, amikor a zuhanykád beépítésére nem standard méretű hely marad, kiegészítő, ún. kompenzációs profilokat fejlesztettünk. Ezek segítségével a standard méretű termékeket kívánt méretre lehet alakítani. Az alábbi oldalakon ellenőrizheti, mely termékek esetében lehetséges ez a megoldás.

Primer uporabe dodatnega profila

Primjer uporabe dodatnoga profila

Primer korišćenja dodatnog profila

Kiegészítő profil használati példája

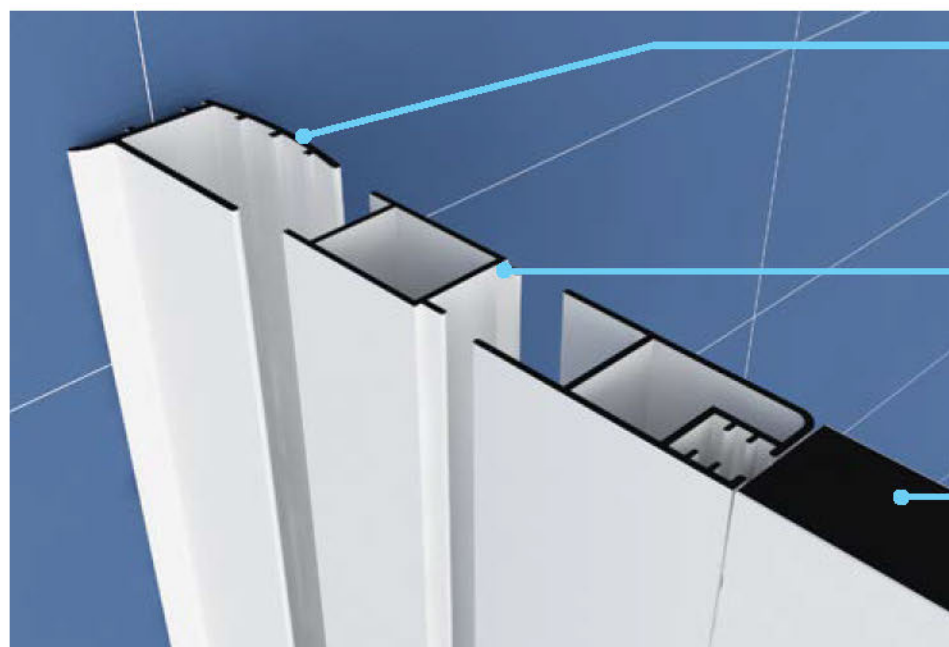

zidni profil
zidni profil
zidni profil
falprofil

dodatni kompenzacijski profil
dodatni kompenzacijski profil
dodatni kompenzacioni profil
kiegészítő kompenzációs profil

tuš vrata
tuš vrata
tuš vrata
zuhanyajtó





Tuš kabine posebnih dimenzij

Tuš kabine posebnih dimenzija
Tuš kabine specijalnih dimenzija
Különleges méretű zuhanyfülkék



Kaj pa če v rednem programu ni rešitve za mojo tuš kabino?

A što ako u redovnom programu nema rješenja za moju tuš kabinu?

Šta ako u redovnom programu nema rešenja za moju tuš kabinu?

Mi történik, ha a rendszeres kínálatban nem létezik megoldás számomra?

V primeru, da vam naše standardne rešitve tuš kabin ne pridejo prav, vam lahko izdelamo rešitev po meri.
Za več informacij o tuš kabinah posebnih dimenzij obiščite spletno stran www.kolpa.si.

U slučaju da vam naša standardna rješenja tuš kabina ne odgovaraju, možemo vam izraditi rješenje po mjeri.
Za više informacija o tuš kabinama posebnih dimenzija posjetite internetsku stranicu www.kolpa.si.

U slučaju da vam naša standardna rešenja tuš kabina ne odgovaraju, možemo vam izraditi rešenje po meri.
Za više informacija o tuš kabinama posebnih dimenzija posetite internet stranu www.kolpa.si.

Amennyiben a standard méretű zuhanykabinok nem megfelelőek számára, méretre is el tudjuk készíteni.
A különleges méretű zuhanykabinokról több adatot talál a www.kolpa.si weblapon.



Možnost prilagoditve višine
Mogućnost prilagodbe visine
Mogućnost prilagođavanja visine
Magasság megváltoztatásának lehetősége



Možnost prilagoditve širine
Mogućnost prilagodbe širine
Mogućnost prilagođavanja širine
Szélesség megváltoztatásának lehetősége



Možnost prilaganja naklonskega kota
Mogućnost prilagođavanja nagibnog kuta
Mogućnost prilagođavanja nagiba
Dőlésszög megváltoztatásának lehetősége



Možnost prilaganja oblike
Mogućnost prilagođavanja oblika
Mogućnost prilagođavanja oblika
Forma megváltoztatásának lehetősége



Možnosti izbire barve profila
Mogućnost odabira boje profila
Mogućnost izbora boje profila
Profilszín kiválasztásának lehetősége

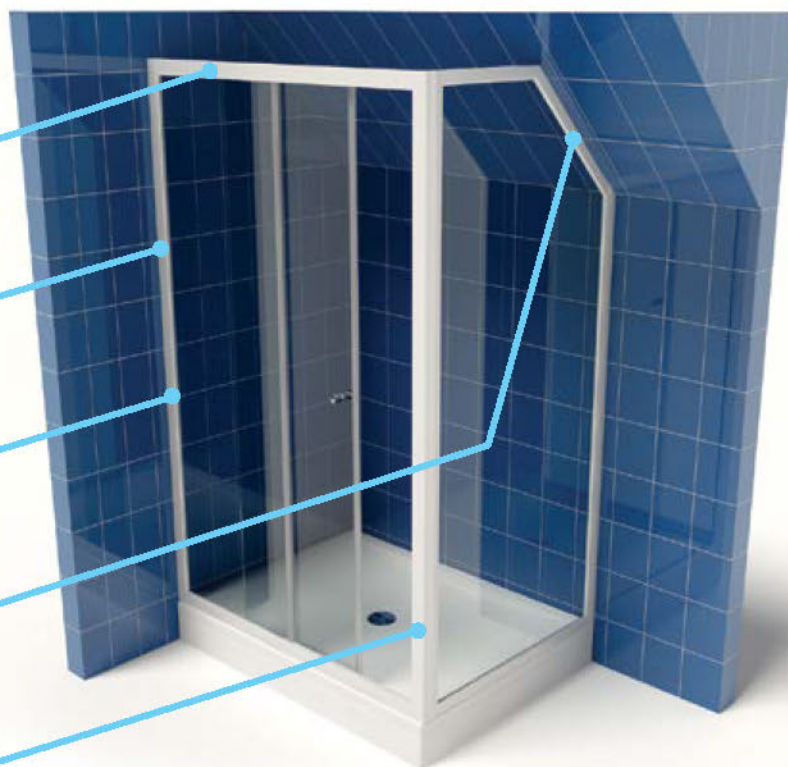

Za zelo zahtevne primere tuš kabin, ki jih ne najdete v tej ponudbi, lahko za kupca poiščemo individualno rešitev.

Za vrlo složene slučajeve tuš kabina koje niste pronašli u ovoj ponudi, za kupca možemo pronaći i individualno rješenje.

Za izuzetno komplikovane slučajeve tuš kabina, ako ih niste našli u ovoj ponudi, možemo za kupca potražiti individualno rešenje.

A kínálatban található igen igényes zuhanykád esetekre a vevők számára egyedi megoldásokat készíthetünk.



Faktorji vodotesnosti tuš kabin po modelih

Čimbenici vodonepropusnosti tuš kabina po modelima

Faktorji zaptivanja tuš kabina po modelima

Zuhanykabinok vízhatlansági tényezői típusonként



Kljub tesnilom na tuš kabini voda še vedno izteka. Je to normalno?

Unatoč brtvilima na tuš kabini voda još uvijek otječe. Je li normalno?

Bez obzira na zaptivke na tuš kabini voda i dalje curi. Da li je to normalno?

A tömítések ellenére a zuhanykádából továbbra is kifolyik a víz. Ez normális?

Tuš kabine ponujajo različne stopnje vodotesnosti, vendar popolne zaščite proti uhajanju vode ni mogoče zagotoviti.

Tuš kabine nude različite stopnje brtvljenja, ali popolnu zaščito od otecanja vode nije moguće osigurati.

Tuš kabine nude različite nivoe zaptivanja, ali se potpuna zaštita od curenja vode ne može obezbediti.

A zuhanykabinok különböző tömítéseket, szigeteléseket kínálnak, a víz teljes megállítása azonban nem lehetséges.

F 1

Faktor 1

Modeli tuš kabin v izvedbi z aluminijastim okvirjem

Ti modeli omogočajo posebno dobre vodotesne lastnosti. Priporočajo se za prhanja z večjo frekvenco in uporabo masažnih prh z veliko količino vode.

Čimbenik 1

Modeli tuš kabina u izvedbi s aluminijaskim okvirom

Ti modeli omogućuju posebno dobra vodonepropusna svojstva. Preporučuju se za tuširanja s većom frekvencijom i uporabom masažnih tuševa s velikom količinom vode.

Faktor 1

Modeli tuš kabina u izvedbi sa aluminijumskim okvirom

Ti modeli omogućavaju posebno dobre osobine u pogledu zaptivanja. Preporučuju se za tuširanja sa većom frekvencijom i korišćenje masažnih tuševa sa velikom količinom vode.

1-es faktor

Alumínium keretű zuhanykabin típusok

Ezek a típusok különösen jó vízhatlansági tulajdonságokkal bírnak. A nagyobb gyakorisággal használt, illetve a nagyobb vízfogyasztású masszázshuzanyok esetében ajánlatosak.

Kabine s spodnjim okvirjem
Kabine s donjim okvirom
Kabine sa donjim okvirom
Kabinok alsó kerettel



F 1



F 2

Faktor 2

Modeli tuš kabin z dodatnim zaščitnim profilom

Dodatno nameščen profil izboljšuje stopnjo zaščite vodotesnosti, vendar je ne more 100% zagotoviti.

Čimbenik 2

Modeli tuš kabina s dodatnim zaštitnim profilom

Dodatno postavljen profil poboljšava stupanj zaštite vodonepropusnosti, ali ju ne može 100% osigurati.

Faktor 2

Modeli tuš kabina sa dodatnim zaštitnim profilom

Dodatno montiran profil poboljšava stepen zaštite u pogledu zaptivanja, ali ga ne može garantovati 100%.

2-es faktor

Zuhanykabinok kiegészítő védőprofilal

A kiegészítő profil növeli a vízhatlanságot, de nem tudja ezt 100%-ban biztosítani.

Dodatni zaščitni profil
Dodatni zaštitni profil
Dodatni zaštitni profil
Kiegészítő védőprofil



F 2



F 3

Faktor 3

Modeli tuš kabin v izvedbi brez aluminijastega okvirja

Imajo zadovoljivo stopnjo zaščite vodotesnosti. Zaradi manjkajočega spodnjega okvirja, ima voda možnost lažjega iztekanja. Kljub temu so ti modeli kabin elegantni, ekskluzivni in omogočajo lažje čiščenje.

Čimbenik 3

Modeli tuš kabina u izvedbi bez aluminijaskog okvira

Imaju zadovoljavajući stupanj zaštite u smislu vodonepropusnosti. Zbog manjkajućega donjeg okvira voda ima mogućnost lakšega istjecanja. Unatoč tomu ti su modeli kabina elegantni, ekskluzivni i omogućuju lakše čišćenje.

Faktor 3

Modeli tuš kabina u izvedbi bez aluminijumskog okvira

Imaju zadovoljavajući stepen zaštite u pogledu zaptivanja. Zbog nepostojećeg donjeg okvira, voda ima mogućnost lakšeg oticanja. Bez obzira na to, ti modeli kabina su elegantni, ekskluzivni i omogućavaju lakše čišćenje.

3-as faktor

Zuhanykabin típusok alumíniumkeret nélkül

Elfogadható vízhatlansági tulajdonságokkal bírnak. A hiányzó alsó keret miatt a víz könnyebben kifolyik. Ennek ellenére ezek a típusok elegánsak, exkluzív kivitelezésűek és könnyebben tisztíthatók.

Kabine brez okvirja
Dodatni zaštitni profil
Kabine bez okvira
Keret nélküli kabinok



F 3



Design tuš zaslonov odreja stopnjo vodotesnosti. Osnovno pravilo je: čim večji in višji je spodnji profil, toliko je višja stopnja zaščite.

Dizajn tuš zaslona određuju stupanj vodonepropusnosti. Osnovno je pravilo: što je veći i viši donji profil, toliko je viši stupanj zaštite.

Dizajn tuš paravana određuje stepen zaptivanja. Osnovno pravilo je: što je viši i veći donji profil, veći je i stepen zaštite.

A zuhanykabinok vízhatlanságát elsősorban a design határozza meg. Az alapszabály: minél nagyobb és magasabb az alsó profil, annál nagyobb a védelem foka.



Pogosta vprašanja - masažne in tuš kabine

Učestala pitanja - masažne i tuš kabine

Česta pitanja - masažne i tuš kabine

Gyakori kérdések - masszáz-és zuhanykádak



Katere prednosti prinaša zaščita stekel nanosan pri tuš kabinah?

Koje prednosti donosi zaštita stakal **nanosan** a kod tuš kabina?

Koje prednosti donosi zaštita stakala **nanosan** kod tuš kabina?

Milyen előnnyel jár az üvegvédelem **nanosan** a zuhanykabinok esetében?



Prednosti zaščite stekel tuš kabin:

- **estetske:** čist in svetleč izgled, ki traja dlje časa. Zaradi odpornosti proti umazaniji, madežem in potemnenju, se podaljša prvotni videz
- **funkcionalne:** omogoča zelo preprosto čiščenje
- **higijske:** omogoča hitrejše splakovanje, ki odstrani umazanijo, sol in bakterije in za sabo ne pušča usedlin in ostankov. Če je steklena površina dlje časa izpostavljena vodi, olajša odstranitev usedle umazanije z večkratnim umivanjem.
- **ekološke:** manjša uporaba bolj agresivnih čistil

Premaz se lahko nanaša tako na nove, kot tudi na rabljene površine.



Prednosti zaštite stakala tuš kabina:

- **estetske:** čist i svetleći izgled koji traje duže vremena. Zbog otpornosti na nečistoće, mrlje i tamnjenje produžuje se prvobitni izgled
- **funkcionalne:** omogućava vrlo jednostavno čišćenje
- **higijenske:** omogućava brže ispiranje koje uklanja nečistoće, sol i bakterije i za sobom ne ostavlja talog i ostatke. Ako je staklena površina duže vrijeme izložena vodi, olakšava uklanjanje nataložene nečistoće koja je nastala višekratnom uporabom.
- **ekološke:** manja potrošnja agresivnijih sredstava za čišćenje

Premaz se može nanositi na nove kao i na već korištene površine.

Prednosti zaštite stakala tuš kabina:

- **estetske:** čist i sjajan izgled koji traje duže vreme. Zbog otpornosti na prljavštinu, fleke i potamnjivanje prvobitni izgled duže traje
- **funkcionalne:** omogućava vrlo jednostavno čišćenje
- **higijenske:** omogućava brže ispiranje koje uklanja prljavštinu, so i bakterije i iza sebe ne ostavlja naslage i ostatke. Ukoliko je staklena površina duže vreme izložena vodi, olakšava uklanjanje naslaga prljavština višekratnim pranjem
- **ekološke:** manja potrošnja agresivnijih sredstava za čišćenje

Premaz može da se nanosi kako na nove, tako i na korišćene površine.

Az üvegvédelem előnyei:

- **esztétikailag** tiszta és fényes, tartósabb üveg. Ellenáll a kosznak, foltoknak, és az elsötétedésnek is, így tovább tűnik újszerűnek.
- **funkcionálisan** igen egyszerű, igen könnyen tisztítható.
- **higiénikusabb**, mivel gyorsabb öblítést tesz lehetővé, így gyorsabban szabadulunk meg a kosztól, a sótól és a baktériumoktól is, nem maradnak lerakódások, illetve ezek jóval könnyebben tisztíthatók.
- **ökológiailag** hatékonyabb, nem követel agresszív szereket.

A védőréteg az új és a használt felületen is alkalmazható.





TERRA

Terra

8 mm prozorno kaljeno staklo
 8 mm kaljeno prozorno staklo
 8 mm prozirno kaljeno staklo
 8 mm átlátszó edzett üveg

1



Silver Brill profili (visokopolirana srebrna galvanska prevleka)
 Silver Brill profili (visokopolirana srebrna galvanska prevleka)
 Silver Brill profili (visokopolirani srebrni galvanski premaz)
 Ezüst Brill profilok (magas fényezésű ezüst galvanizált burkolat)

2



4

kromirani tečajji z dvizžno funkcijo
 kromirane šarke s podiznom funkcijom
 hromirane šarke sa funkcijom podizanja
 krómozott pántok emelőfunkcióval

zapiranje z magnetnim profilom
 zatvaranje s magnetskim profilom
 zatvaranje pomoću magnetnog profila
 zárás mágneses profillal

3



dodatni nosilci
 dodatni nosači
 dodatni nosači
 kiegészítő hordozóelemek

5



kromirani tečajji pogreznjeni v steklo na notranji strani kabine omogočajo lažje čiščenje
 kromirane šarke utisnute u staklo na unutarnjoj strani kabine omogućuju lakše čišćenje
 hromirane šarke, potopljene u staklo s unutrašnje strane kabine, omogućavaju lakše čišćenje
 krómozott üvegbe süllyesztett pántok a kabin belsejében a könnyebb tisztítás miatt

6



dodatni aluminijski profil na tuš kadi preprečuje iztekanje vode
 dodatni aluminijski profil na tuš kadi sprječava istjecanje vode
 dodatni aluminijski profil na tuš kadi sprečava izlivanje vode
 kiegészítő alumínium profil, amely megakadályozza a víz kifolyását

7

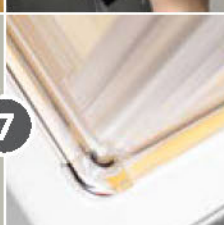

Terra

Terra			A	B					nanosan
Terra TKK 90			88 - 89	86,5 - 87,5	195	75			
Terra TKK 100			98 - 99	96,5 - 97,5	195	75			
Terra TKP 90			88 - 89	86,5 - 87,5	195	86	55		
Terra TKP 100			98 - 99	96,5 - 97,5	195	86	55		
Terra TV/S 90 -L, -D			88 - 90	88 - 90	195	53			
Terra TV/S 100 -L, -D			98 - 100	98 - 100	195	53			
Terra TV 90 -L, D			88 - 89	86,5 - 87,5	195	53			
Terra TSv 80			78 - 79	76,5 - 77,5	195	53			
Terra TSv 90			88 - 89	86,5 - 87,5	195	53			
Terra TS 78					150	78			



Silver Brill
 Silver Brill
 Silver Brill
 Ezüst Brill



Kaljeno prozorno staklo
 Kaljeno prozorno staklo
 Kaljeno prozorno staklo
 Edzett átlátszó üveg



Ugradna mera na tuš kadi
 Ugradbena mjera na tuš kadi
 Ugradna mera na tuš kadi
 Beépítési méretek a zuhanykád



Ugradna mera na tla (ploščice)
 Ugradbena mjera na podu (ploščice)
 Ugradna mera na podu (ploščice)
 Beépítési méretek a padlón (csempe)



Hora stone, Hora
tile stone,
Canary,
Haka,
Salsa,
Rock,
Trin,
Boston,
Flamenco,
Salsa,
Step zero,
Lerock zero.



Macarena,
Bebop,
Ontex,
Eisa,
Blues,
Pony.



› 140-225 › 112-118 › 297 › 289-295 › 301 › 148

Tuš kabina z dvema vratnima kriloma na tečajih.
Kotna in polkrožna izvedba.

Kabina je primerna za tuš kadi:

Tuš-kabina s dva vratna krila na šarkama.
Kutna i polukružna izvedba.

Kabina primjerena je za sljedeće tuš kade:

Tuš kabina sa dva vratna krila na šarkama.
Ugaona i polukružna izvedba.

Kabina je odgovarajuća za tuš kade:

Zuhanykabin két ajtószármnyal.
Sarkos és félköríves kivitelezés.

A kabin a következő zuhanytálcákhoz ajánlott

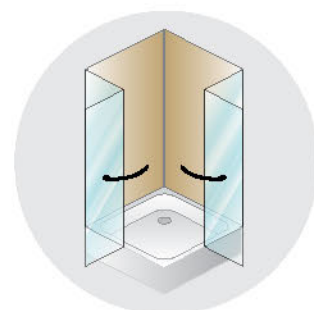

Terra TTK 100,90

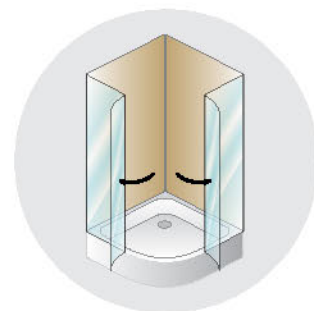

Terra TKP 100,90

Terra TTK 90			88 - 89	86,5 - 87,5	195	75				
Terra TTK 100			98 - 99	96,5 - 97,5	195	75				
Terra TKP 90			88 - 89	86,5 - 87,5	195	82	55			
Terra TKP 100			98 - 99	96,5 - 97,5	195	82	55			

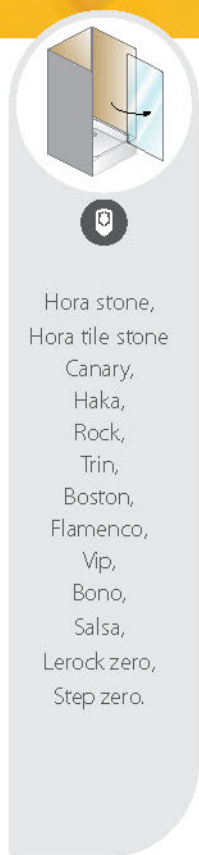
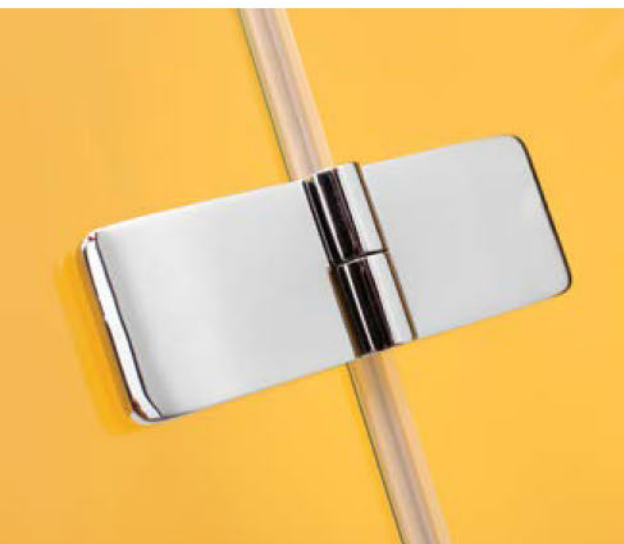

Samostojna tuš vrata.

Vrata so primerna za tuš kadi:

Samostojeća tuš vrata.

Vrata su primjerena za sljedeće tuš kade:

Samostojeća vrata za tuš kabinu.

Vrata su odgovarajuća za tuš kade:

Önálló zuhanyajtó két fal közé.

Az ajtó a következő zuhanytálcákhoz ajánlott:



TerraTV/S 100,90 - L



TerraTV/S 100,90 - D

TerraTV/S 90 - L,-D			88 - 90	88 - 90	195	53			
TerraTV/S 100 - L,-D			98 - 100	98 - 100	195	53			

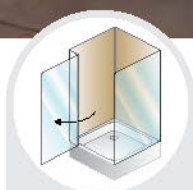

Hora stone,
Hora tile stone,
Canary,
Haka,
Rock,
Trin,
Boston,
Flamenco,
Vip,
Bono,
Salsa.



› 140-225 › 112-118 › 297 › 289-295 › 301 › 148

Tuš vrata s tuš steno.

Vrata in stena so primerne za tuš kadi:

Tuš vrata s tuš panelom.

Vrata i panel su primjereni za sljedeće tuš kade:

Tuš vrata sa tuš zidom.

Vrata i stena su odgovarajuća za tuš kade:

Zuhanyajtó zuhanyfallal.

Az ajtók és a zuhanyfalak a következő zuhanytál-
cákhöz ajánlottak:

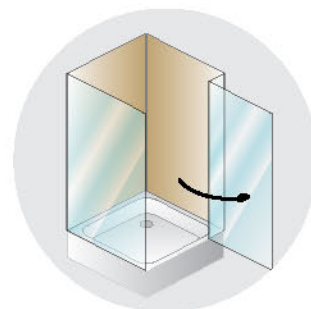
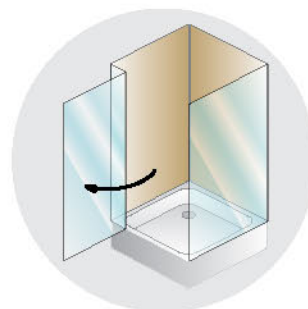

Terra TV 90 + TSv 90, 80 - L

Terra TV 90 + TSv 90, 80 - D

										nanosan
Terra TV 90 -L, -D			88 - 89	86,5 - 87,5	195	53				
Terra TSv 80 -L, -D			78 - 89	76,5 - 77,5	195	53				
Terra TSv 90 -L, -D			88 - 89	86,5 - 87,5	195	53				

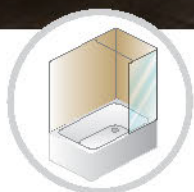

› 140-225 › 112-118 › 297 › 289-295 › 301 › 148

Enodelni krilni zaslon za kopalne kadi.

Jednodijelni krilni paravan za kupaonske kade.

Tuš paravan za kade.

Zuhanyfal fűrdőkádhoz.



Terra TS 78 - L

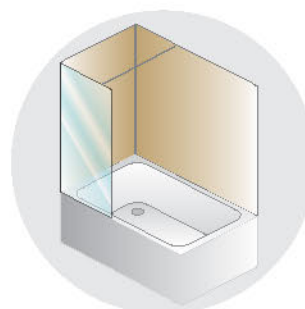

Terra TS 78 - D



nanosan

Terra TS 78 -L,D

150

78 - 79



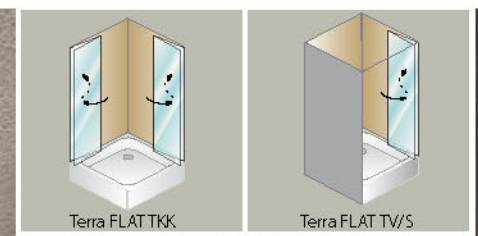

TERRA FLAT

Terra flat

6 mm prozorno kaljeno steklo
6 mm kaljeno prozorno staklo
6 mm prozirno kaljeno staklo
6 mm átlátszó edzett üveg

1



Silver Brill profil (visokopolirana srebrna galvanska prevleka)
Silver Brill profil (visokopolirana srebrna galvanska prevleka)
Silver Brill profil (visokopolirani srebrni galvanski premaz)
Ezüst Brill profilok (magas fényezésű ezüst galvanizált burkolat)

2



zapiranje z magnetnim profilom
zatvaranje s magnetskim profilom
zatvaranje pomoću magnetnog profila
zárás mágneses profillal

3



kromirani tečaji z dvizhno funkcijo
kromirane šarke s podiznom funkcijom
hromirane šarke sa funkcijom podizanja
krómozott pántok emelőfunkcióval

4



kromirani tečaji pogreznjeni v steklo na notranji strani kabine omogočajo lažje čiščenje
kromirane šarke utisnute u staklo na unutrašnjoj strani kabine omogućuju lakše čišćenje
hromirane šarke, potopljene u staklo s unutrašnje strane kabine, omogućavaju lakše čišćenje
krómozott üvegebe süllyesztett pántok a kabin belsejében a könnyebb tisztítás miatt

5







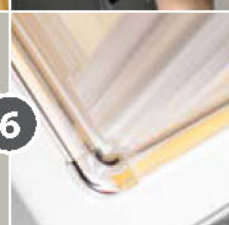























dobatni aluminijski profil na tuš kadi preprečuje iztekanje vode
dobatni aluminijski profil na tuš kadi sprječava istjecanje vode
dobatni aluminijski profil na tuš kadi sprečava izlivanje vode
kiegészítő alumínium profil, amely megakadályozza a víz kifolyását

6



Terra flat

			A 	B 						nanosan
Terra FLAT TTK 90			88,5 x 89,5	87 - 88	200	111				
Terra FLAT TTK 100			98,5 x 99,5	97 - 98	200	125				
Terra FLAT TV/S 70 - L, D			68 x 70	68 x 70	200	55				
Terra FLAT TV/S 80 - L, -D			78 x 80	78 x 80	200	65				
Terra FLAT TV/S 90 - L, -D			88 - 90	88 x 90	200	75				



Silver Brill
Silver Brill
Silver Brill
Ezüst Brill



Kaljeno prozorno steklo
Kaljeno prozorno staklo
Kaljeno prozirno staklo
Edzett átlátszó üveg



Ygradna mera na tuš kadi
Ugradbena mjera na tuš kadi
Ugradna mera na tuš kadi
Beépítési méretek a zuhanykád



Vgradna mera na tla (ploščice)
Ugradbena mjera na podu (ploščice)
Ugradna mera na podu (ploščice)
Beépítési méretek a padlón (csempé)



Canary,
Haka,
Salsa,
Rock, Trin,
Boston,
Flamenco,
Step zero,
Lerock zero.



› 140-225 › 112-118 › 297 › 289-295 › 301 › 148

Kotna tuš kabina, zložljiva na notranjo ali zunanjo stran.

Kabina je primerna za tuš kade:

Kutna tuš kabina, sklopiva na unutrašnju i vanjsku stranu.

Kabina primjerena je za sljedeće tuš kade:

Ugaona tuš kabina, sklopiva na unutrašnju ili spoljašnju stranu.

Kabina je odgovarajuća za tuš kade:

Sarok zuhanykabin, összecukható a belső vagy a külső oldal irányában.

A kabin a következő zuhanytálcákhoz ajánlott:



nanosan

Terra FLAT TTK 90



88,5 x 89,5

87 x 88

200

111



Terra FLAT TTK 100



98,5 x 99,5

97 x 98

200

125



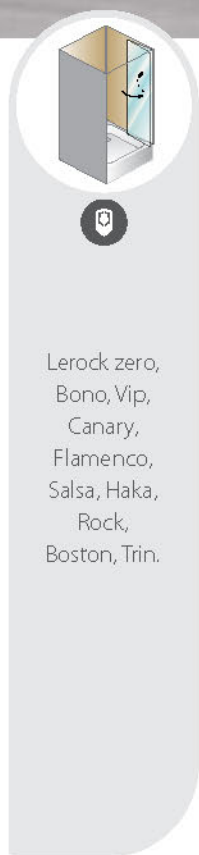

Samostojna tuš vrata, zložljiva na notranjo ali zunanjo stran.
Kabina je primerna za tuš kadi:

Samostojeća tuš vrata, sklopiva na unutrašnju i vanjsku stranu.
Kabina primjerena je za sljedeće tuš kade:

Samostojeća tuš vrata, sklopiva na unutrašnju ili spoljašnju stranu.
Kabina je odgovarajuća za tuš kade:

Önálló zuhanyajtó, összecukható a belső vagy a külső oldal irányában.
A kabin a következő zuhanytálcákhoz ajánlott:

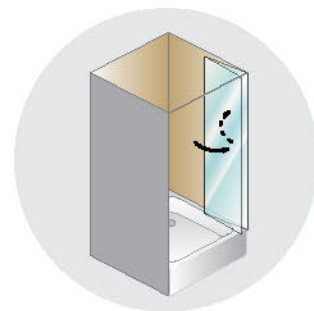

Terra FLATTV/S 70 -L, -D			68 x 70	68 x 70	200	55			
Terra FLATTV/S 80 -L, -D			78 x 80	78 x 80	200	65			
Terra FLATTV/S 90 -L, -D			88 x 90	88 x 90	200	75			

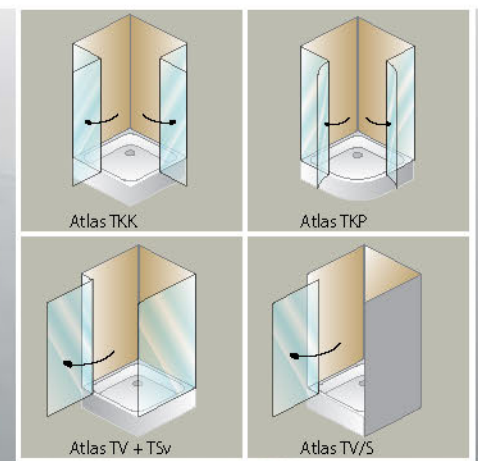

ATLAS

Atlas

8 mm prozorno kaljeno steklo
 8 mm kaljeno prozorno staklo
 8 mm prozirno kaljeno staklo
 8 mm átlátszó edzett üveg

1



Silver Brill profili (visokopolirana srebrna galvanska prevleka)
 Silver Brill profili (visokopolirana srebrna galvanska prevleka)
 Silver Brill profili (visokopolirani srebrni galvanski premaz)
 Ezüst Brill profilok (magas fényezésű ezüst galvanizált burkolat)

2



zapiranje z magnetnim profilom
 zatvaranje s magnetskim profilom
 zatvaranje pomoću magnetnog profila
 zárás mágneses profillal

3



chromed hinges with lift function
 Chromscharniere mit Hebefunktion
 charnières chromées avec une fonction de levage
 хромированные петли с функцией подъема

4



dodatni nosilci
 dodatni nosači
 dodatni nosači
 kiegészítő hordozóelemek

5



dodatni aluminijski profil na tuš kadi preprečuje iztekanje vode
 dodatni aluminijski profil na tuš kadi sprječava istjecanje vode
 dodatni aluminijski profil na tuš kadi sprečava izlivanje vode
 kiegészítő alumínium profil, amely megakadályozza a víz kifolyását

6



Atlas									nanosan
Atlas TKK 90			87,5 - 89,5	200	68,5				
Atlas TKK 100			97,5 - 99,5	200	68,5				
Atlas TKP 90			88,5 - 89,5	200	72				
Atlas TKP 100			98,5 - 99,5	200	72				
Atlas TV/S 90 -L, -D			88 - 90	200	53				
Atlas TV/S 100 -L, -D			98 - 100	200	53				
Atlas TV/S 120 -L, -D			118 - 120	200	57				
Atlas TV 90 -L, -D			88 - 90	200	53				
Atlas TV 100 -L, -D			98 - 100	200	53				
Atlas TV 120 -L, -D			118 - 120	200	57				
Atlas TSv 80			78 - 79	200					
Atlas TSv 90			88 - 89	200					



Silver Brill
 Silver Brill
 Silver Brill
 Ezüst Brill



Kaljeno prozorno steklo
 Kaljeno prozirno staklo
 Kaljeno providno staklo
 Edzett átlátszó üveg



Výhradna mera
 Ugradbena mjera
 Ugradna mera
 Beépítési méretek



Hora stone, Hora
tile stone,
Canary,
Haka,
Salsa,
Rock,
Trin,
Boston,
Flamenco,
Salsa,
Step zero,
Lerock zero.



Macarena,
Bebop,
Ontex,
Eisa,
Blues,
Pony.



› 140-225 › 112-118 › 297 › 289-295 › 301 › 148

Kotna tuš kabina z dvema vratnima kriloma na težajih.

Kabina je primerna za tuš kadi:

Kutna tuš kabina s dva vratna krila na šarkama.

Kabina primjerena je za sljedeće tuš kade:

Četvrtasta tuš kabina sa dva vratna krila na šarkama.

Kabina je odgovarajuća za tuš kade:

Négyszögletes zuhanykabin két egyenes ajtóval, zsanérokkaal.

A kabin a következő zuhanytálcákhoz ajánlott:

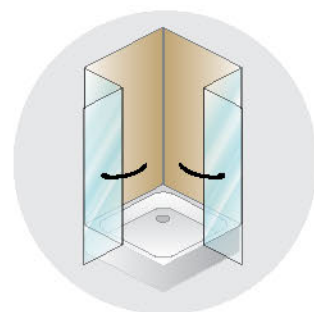

AtlasTKK 100, 90



AtlasTKP 100, 90

									nanosan
AtlasTKK 90			87,5 - 89,5	200	68,5				
AtlasTKK 100			97,5 - 99,5	200	68,5				
AtlasTKP 90			88,5 - 89,5	200	72		55		
AtlasTKP 100			98,5 - 99,5	200	72		55		

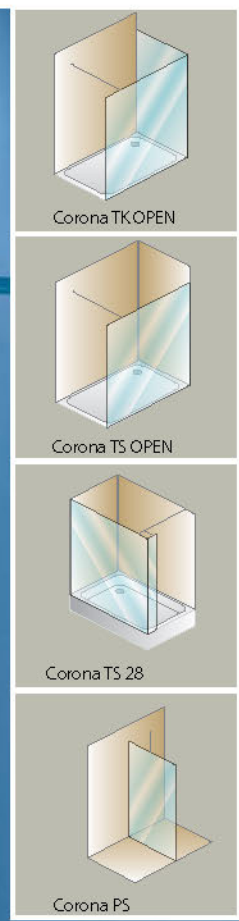

CORONA

Corona

8 mm prozorno kaljeno steklo
 8 mm kaljeno prozorno staklo
 8 mm prozirno kaljeno staklo
 8 mm átlátszó edzett üveg

6 mm prozorno kaljeno steklo - TS OPEN 90, 100
 6 mm kaljeno prozorno staklo - TS OPEN 90, 100
 6 mm prozirno kaljeno staklo - TS OPEN 90, 100
 6 mm átlátszó edzett üveg - TS OPEN 90, 100

1



Silver Brill profíli (visokopolirana srebrna galvanska prevleka)
 Silver Brill profíli (visokopolirana srebrna galvanska prevleka)
 Silver Brill profíli (visokopolirani srebrni galvanski premaz)
 Ezüst Brill profílok (magas fényezésű ezüst galvanizált burkolat)

2



Corona			A	B					nanosan
Corona TK OPEN 120x80, 140x80			116/136 x 77,5 - 78,5		200(204)	77			
Corona TK OPEN 120x90, 140x90			116/136 x 87,5 - 89,5		200(204)	87			
Corona TS OPEN 90, 100					200(204)		88,5 98,5		
Corona TS OPEN 120, 140					200(204)		118 138		
Corona TS 28 OPEN					200(204)		28		
Corona PS 82					185		81,5 - 82		
Corona PS 69					182		68,5 - 69		
Corona PS 54					177		53,5 - 54		
Corona PS 57					177		56,5 - 57		
Corona PS 61					177		60,5 - 61		
Corona PS 64					177		63,5 - 64		



Silver Brill
 Silver Brill
 Silver Brill
 Ezüst Brill



Kaljeno prozorno steklo
 Kaljeno prozorno staklo
 Kaljeno prozorno staklo
 Edzett átlátszó üveg



Ugradna mera na tuš kad
 Ugradbena mjera na tuš kadu
 Ugradna mera na tuš kadu
 Beépítési méretek a zuhanykád



Ugradna mera na tla (ploščice)
 Ugradbena mjera na podu (ploščice)
 Ugradna mera na podu (ploščice)
 Beépítési méretek a padlón (csempe)

Tuš kabina z možnostjo postavitve na tuš kad ali samostojne vgradnje (brez tuš kade).
Možnost vgradnje levo ali desno.

Tuš kabina s mogućnošću postavljanja na tuš kadu ili izravno na tlo (bez tuš kade).
Mogućnost montaže lijevo ili desno.

Tuš kabina sa mogućnošću montaže na tuš kadu ili direktno na pod (bez tuš kade).
Mogućnost ugradnje levo ili desno.

Zuhanykádra illetve közvetlen a padlóra (zuhanykád nélkül) állítható zuhanykabin.
Beépítési lehetőség: balra vagy jobbra nyíló.

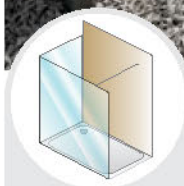

Lerock zero,
Vip,
Bono,
Canary,
Flamenco,
Salsa,
Haka,
Vals.



> 140-225 > 112-118 > 297 > 289-295 > 301 > 148

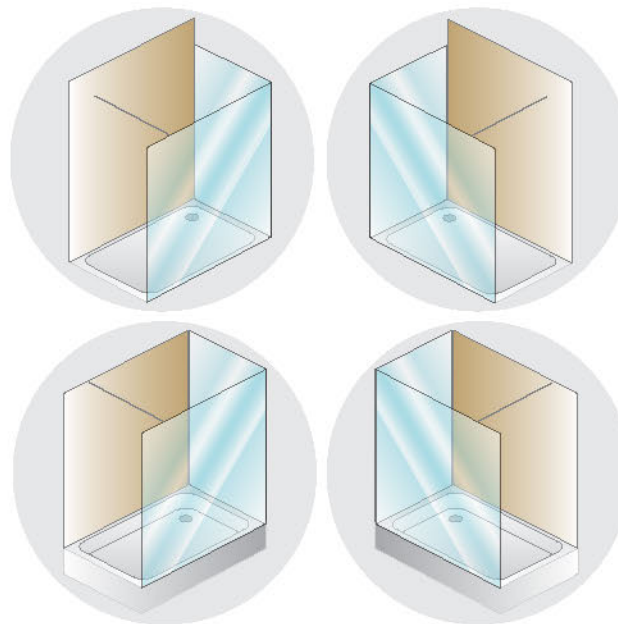

CoronaTK OPEN

								nanosan
Corona TK OPEN 120 x 80			A+	200 (204)	77	77		
Corona TK OPEN 140 x 80			A+	200 (204)	77	77		
Corona TK OPEN 120 x 90			A+	200 (204)	87	87		
Corona TK OPEN 140 x 90			A+	200 (204)	87	87		



Lerock zero,
Vip,
Bono,
Canary,
Flamenco,
Salsa,
Haka,
Vals.



› 140-225 › 112-118 › 297 › 289-295 › 301 › 148

Dodatna tuš stena za kombinacijo s TK OPEN 120, 140.

Primerna za tuš kadi:

Dodatna tuš stjenka za kombinacijo s TK OPEN 120, 140.

Primjerena za sljedeće tuš kade:

Dodatni tuš zid za kombinaciju sa TK OPEN 120, 140.

Odgovarajuća za tuš kade:

Kiegészítő zuhanyfal a TK OPEN 120, 140 termékekhez.

A kabin a következő zuhanytálcákhoz ajánlott:

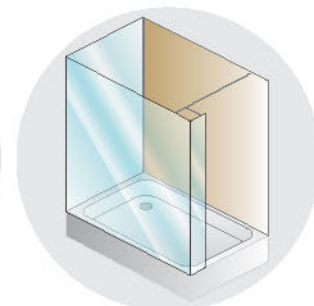
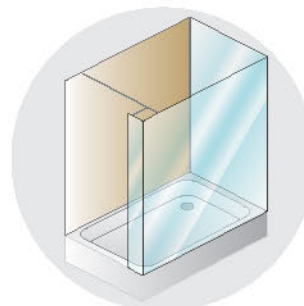
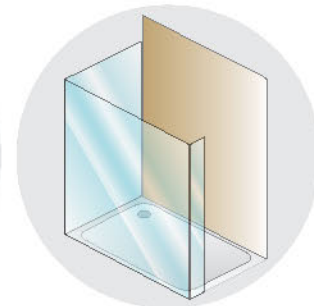
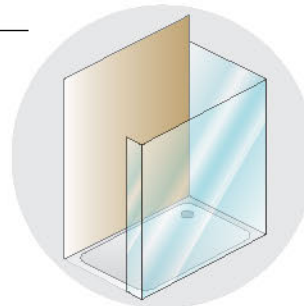

Corona TK OPEN + TS



nanosan

Corona TS OPEN 28



200 (204)

28



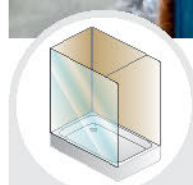

Canary,
Vip, Bono,
Rock, Trin,
Boston,
Flamenco,
Step zero,
Lerock zero,
Salsa,
Haka,
Vals.



› 140-225 › 112-118 › 297 › 289-295 › 301 › 148

Tuš stena OPEN z možnostjo postavitve na tuš kad ali direktno na tla (brez tuš kade).

Možnost vgradnje levo ali desno.

Stabilizator L= 70-120 cm.

Tuš stijena OPEN s mogućnošću postavljanja na tuš kadu ili izravno na tlo (bez tuš kade).

Mogućnost montaže lijevo ili desno.

Stabilizator L= 70-120 cm.

Tuš zid OPEN sa mogućnošću montaže na tuš kadu ili direktno na pod (bez tuš kade).

Mogućnost ugradnje levo ili desno.

Stabilizator L= 70-120 cm.

Zuhanykádra illetve közvetlen a padlóra (zuhanykád nélkül) állítható OPEN zuhany – zuhanyfal.

Beépítési lehetőség: balra vagy jobbra nyíló.

Stabilizátor L= 70-120 cm.

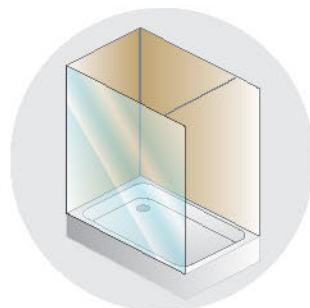
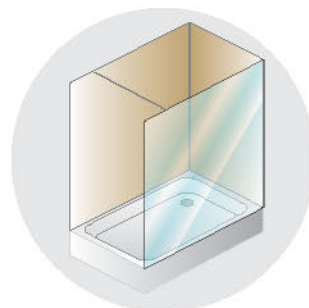
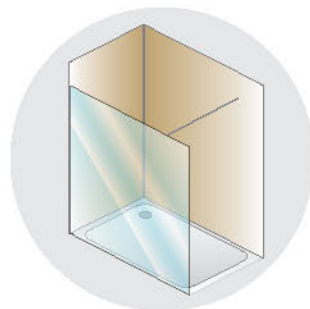
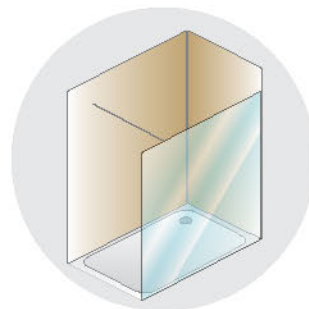

Corona TS OPEN



nanosan

Corona TS OPEN 90									200 (204)	88,5		
Corona TS OPEN 100									200 (204)	98,5		
Corona TS OPEN 120									200 (204)	117		
Corona TS OPEN 140									200 (204)	137		

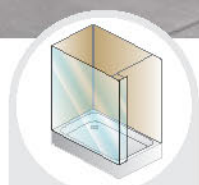

Lerock zero,
Vip,
Bono,
Canary,
Flamenco,
Salsa,
Haka,
Vals.



› 140-225 › 112-118 › 297 › 289-295 › 301 › 148

Dodatna tuš stena za kombinacijo s TS OPEN 120, 140.
Primerna za tuš kadi:

Dodatna tuš stjenka za kombinacijo s TS OPEN 120, 140.
Primjerena za sljedeće tuš kade:

Dodatni tuš zid za kombinaciju sa TS OPEN 120, 140.
Odgovarajuća za tuš kade:

Kiegészítő zuhanyfal a TS OPEN 120, 140 termékekhez.
A kabin a következő zuhanytálcákhoz ajánlott:

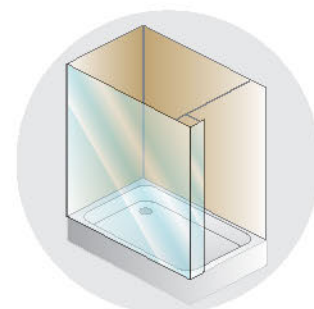

Corona TS OPEN + TS



nanosan

Corona TS OPEN 28



200 (204)

28



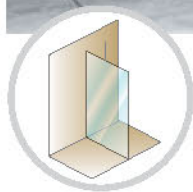

› 140-225 › 112-118 › 297 › 289-295 › 301 › 148

Pregradna stena, samostojna, s kromirano oporo.

Možnost postavitve opore na levo ali desno stran.

Pregradna stijena, samostojeća, s kromiranim potporu.

Mogućnost postavljanja oslonca na lijevu ili desnu stranu.

Pregradni zid, samostojeći, s hromiranim potporu.

Mogućnost postavljanja potpore na levu ili desnu stranu.

Válaszfal, önálló, króm támogatás.

A támasztóelemek szerelhetők balra és jobbra is.

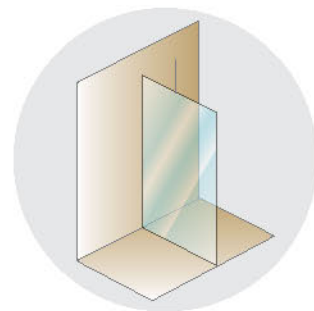

Corona PS 82, 69, 64, 61, 57, 54

								nanosan
Corona PS 82				185		81,5 - 82		
Corona PS 69				182		68,5 - 69		
Corona PS 64				177		63,5 - 64		
Corona PS 61				177		60,5 - 61		
Corona PS 57				177		56,5 - 57		
Corona PS 54				177		53,5 - 54		



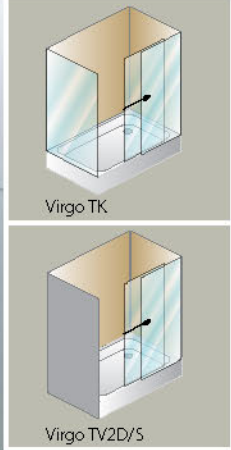

VIRGO NEW

Virgo NEW

8 mm prozorno kaljeno steklo
8 mm kaljeno prozorno staklo
8 mm prozirno kaljeno staklo
8 mm átlátszó edzett üveg

1



Silver Brill profili (visokopolirana srebrna galvanska prevleka)
Silver Brill profili (visokopolirana srebrna galvanska prevleka)
Silver Brill profili (visokopolirani srebrni galvanski premaz)
Ezüst Brill profilok (magas fényezésű ezüst galvanizált burkolat)

2



zapiranje z magnetnim profilom
zatvaranje s magnetskim profilom
zatvaranje pomoću magnetnog profila
zárás mágneses profillal

3



dodatni aluminijski profil na tuš kadi sprečava iztekanje vode
 dodatni aluminijski profil na tuš kadi sprečava istjecanje vode
 dodatni aluminijski profil na tuš kadi sprečava izlivanje vode
 kiegészítő alumínium profil, amely megakadályozza a víz kifolyását

4



široka vhodna odprtina brez vstopne ovire
širok ulazni otvor bez ulazne prepreke
široka ulazna vrata bez ulazne prepreke
széles bejárati nyílás bejárati akadály nélkül

5



vratno krilo na masivnih krogličnih ležajjih
 vratno krilo na masivnim kugličnim ležajevima
 ajtószárny masszív golyóscsapágyakon

6



tesnilni profil do talne površine preprečuje uhajanje odbijajoče vode
brtveni profil do podne površine sprečava ulazak odbijajuće vode
zaptivni profil do podne površine sprečava curenje vode koja se odbija
tömítőprofil a padlózatig akadályozza meg a lepörgő víz kifolyását

7



držalo za brisače
držač ručnika
držač za peškire
törülközőtartó

9



demontažni čep omogoča lažje čiščenje
demontažni čep omogočuje lakše čišćenje
demontažni čep omogočava lakše čišćenje
a kiszerelési dugó a könnyebb tisztítást teszi lehetővé

8



Virgo										nanosan
Virgo NEW TK 120x80 -L, -D				118,5 - 119 x 79 - 80	200	46				
Virgo NEW TK 120x90 -L, -D				118,5 - 119 x 89 - 90	200	46				
Virgo NEW TK 140x80 -L, -D				138,5 - 139 x 79 - 80	200	56				
Virgo NEW TK 140x90 -L, -D				138,5 - 139 x 89 - 90	200	56				
Virgo NEW TK 160x80 -L, -D				158,5 - 159 x 79 - 80	200	66				
Virgo NEW TK 160x90 -L, -D				158,5 - 159 x 89 - 90	200	66				
Virgo NEW TV2D/S 120 -L, -D				119 - 120	200	46				
Virgo NEW TV2D/S 140 -L, -D				139 - 140	200	56				
Virgo NEW TV2D/S 160 -L, -D				159 - 160	200	66				



Silver Brill
Silver Brill
Silver Brill
Ezüst Brill



Kaljeno prozorno steklo
Kaljeno prozirno staklo
Kaljeno prozorno staklo
Edzett átlátszó üveg



Vgradna mera
Ugradbena mjera
Ugradna mera
Beépítési méretek



Canary,
Lerock zero,
Vip,
Bono,
Salsa,
Haka,
Flamenco,
Vals.



› 140-225 › 112-118 › 297 › 289-295 › 301 › 148

Tuš kabina - vrata in stena, levo ali desno enostransko odpiranje.

Kabina je primerna za tuš kadi:

Tuš kabina - vrata i stijena, lijevo ili desno jednostrano otvaranje

Tuš kabina je primjerena za sljedeće tuš kade:

Tuš kabina - vrata i zid, levo ili desno jednostrano otvaranje

Kabina je odgovarajuća za tuš kade:

Zuhanykabin - ajtó és fal, bal vagy jobb egyirányú nyitással

A kabin a következő zuhanytálcákhoz ajánlott:

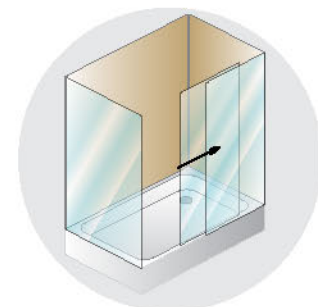
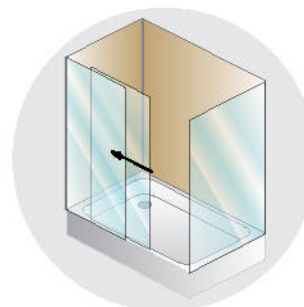

Virgo NEW TK 160, 140, 120 - L

Virgo NEW TK 160, 140, 120 - D

								nanosan
Virgo NEW TK 120 x 80-L,-D			118,5 - 119 x 79 - 80	200	46			
Virgo NEW TK 120 x 90-L,-D			118,5 - 119 x 89 - 90	200	46			
Virgo NEW TK 140 x 80-L,-D			138,5 - 139 x 79 - 80	200	56			
Virgo NEW TK 140 x 90-L,-D			138,5 - 139 x 89 - 90	200	56			
Virgo NEW TK 160 x 80-L,-D			158,5 - 159 x 79 - 80	200	66			
Virgo NEW TK 160 x 90-L,-D			158,5 - 159 x 89 - 90	200	66			

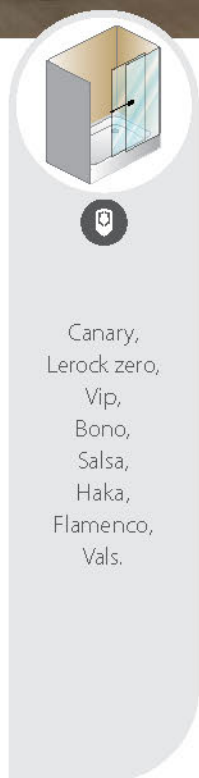

Samostojna tuš vrata, enostransko odpiranje.
Vrata so primerna za tuš kadi:

Samostalna tuš vrata, jednostrano otvaranje
Vrata su primjerena za sljedeće tuš kade:

Samostojeća tuš vrata, jednostrano otvaranje
Vrata su odgovarajuća za tuš kade:

Önálló zuhanyajtó, egyirányú nyitással
Az ajtó a következő zuhanytálcákhoz ajánlott:

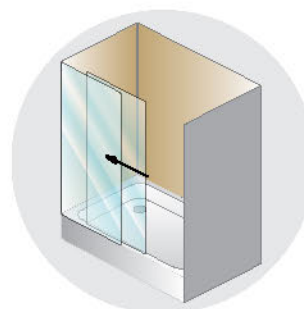

Virgo TK 160, 140, 120 - L



Virgo TK 160, 140, 120 - D

								nanosan
Virgo NEW TV2D/S 120 - L, D			119 - 120	200	46			
Virgo NEW TV2D/S 140 - L, D			139 - 140	200	56			
Virgo NEW TV2D/S 160 - L, D			159 - 160	200	66			



KRONOS NEW

Kronos NEW

8 mm prozorno kaljeno steklo
8 mm kaljeno prozorno staklo
8 mm prozirno kaljeno staklo
8 mm átlátszó edzett üveg

1



Silver Brill profili (visokopolirana srebrna galvanska prevleka)
Silver Brill profili (visokopolirana srebrna galvanska prevleka)
Silver Brill profili (visokopolirani srebrni galvanski premaz)
Ezüst Brill profilok (magas fényezésű ezüst galvanizált burkolat)

2



zapiranje z magnetnim profilom
zatvaranje s magnetskim profilom
zatvaranje pomoću magnetnog profila
zárás mágneses profillal

3



dotadni aluminijski profil na tuš kadi preprečuje iztekanje vode
dotadni aluminijski profil na tuš kadi sprječava istjecanje vode
dotadni aluminijski profil na tuš kadi sprečava izlivanje vode
kiegészítő alumínium profil, amely megakadályozza a víz kifolyását

4



široka vhodna odprtina brez vstopne ovire
širok ulazni otvor bez ulazne prepreke
široka ulazna vrata bez ulazne prepreke
széles bejárati nyílás bejárati akadály nélkül

5



tesnilni profil do talne površine preprečuje uhajanje odbijajoče vode
brtveni profil do podne površine sprečava ulazak odbijajuće vode
zaptivni profil do podne površine sprečava curenje vode koja se odbija
tömítőprofil a padlózatig akadályozza meg a lepörgő víz kifolyását

6



držalo za brisače
držać ručnika
držač za peškire
törülközőtartó

7



Kronos								nanosan
Kronos NEW TK 120x80 -L, -D			118 x 78 - 118,5 x 78,5	200	44			
Kronos NEW TK 120x90 -L, -D			118 x 88 - 118,5 x 88,5	200	44			
Kronos NEW TK 140x80 -L, -D			138 x 78 - 138,5 x 78,5	200	52			
Kronos NEW TK 140x90 -L, -D			138 x 88 - 138,5 x 88,5	200	52			
Kronos NEW TK 160x80 -L, -D			158 x 78 - 158,5 x 78,5	200	62			
Kronos NEW TK 160x90 -L, -D			158 x 88 - 158,5 x 88,5	200	62			
Kronos NEW TV2D/S 120 -L, -D			119 - 120	200	44			
Kronos NEW TV2D/S 140 -L, -D			139 - 140	200	52			
Kronos NEW TV2D/S 160 -L, -D			159 - 160	200	62			



Silver Brill
Silver Brill
Silver Brill
Ezüst Brill



Kaljeno prozorno steklo
Kaljeno prozirno staklo
Kaljeno prozorno staklo
Edzett átlátszó üveg



Ugradna mera
Ugradna mera
Ugradna mera
Beépítési méretek

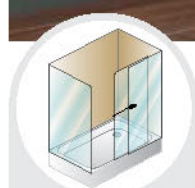

Canary,
Lerock zero,
Vip,
Bono,
Salsa,
Haka,
Flamenco,
Vals.



› 140-225 › 112-118 › 297 › 289-295 › 301 › 148

Tuš kabina - vrata in stena, levo ali desno enostransko odpiranje.

Kabina je primerna za tuš kadi:

Tuš kabina - vrata i stijena, lijevo ili desno jednostrano otvaranje

Tuš kabina je primjerena za sljedeće tuš kade:

Tuš kabina - vrata i zid, levo ili desno jednostrano otvaranje

Kabina je odgovarajuća za tuš kade:

Zuhanykabin - ajtó és fal, bal vagy jobb egyirányú nyitással

A kabin a következő zuhanytálcákhöz ajánlott:

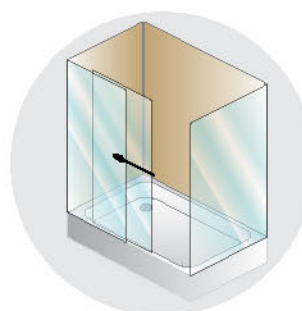

Kronos NEW TK
160, 140, 120 - L

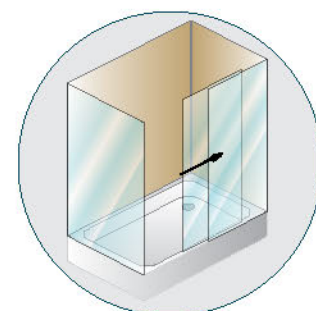

Kronos NEW
TK 160, 140, 120 - D

								nanosan
Kronos NEW TK 120 x 80 -L, -D			118 x 78 - 118,5 x 78,5	200	44			
Kronos NEW TK 120 x 90 -L, -D			118 x 88 - 118,5 x 88,5	200	44			
Kronos NEW TK 140 x 80 -L, -D			138 x 78 - 118,5 x 78,5	200	52			
Kronos NEW TK 140 x 90 -L, -D			138 x 88 - 118,5 x 88,5	200	52			
Kronos NEW TK 160 x 80 -L, -D			158 x 78 - 118,5 x 78,5	200	62			
Kronos NEW TK 160 x 90 -L, -D			158 x 88 - 118,5 x 88,5	200	62			



Canary,
Lerock zero,
Vip,
Bono,
Salsa,
Haka,
Flamenco,
Vals.



› 140-225 › 112-118 › 297 › 289-295 › 301 › 148

Samostojna tuš vrata, enostransko odpiranje.

Vrata so primerna za tuš kadi:

Samostalna tuš vrata, jednostrano otvaranje

Vrata su primjerena za sljedeće tuš kade:

Samostojeća tuš vrata, jednostrano otvaranje

Vrata su odgovarajuća za tuš kade:

Önálló zuhanyajtó, egyirányú nyitással

Az ajtó a következő zuhanytálcákhoz ajánlott:

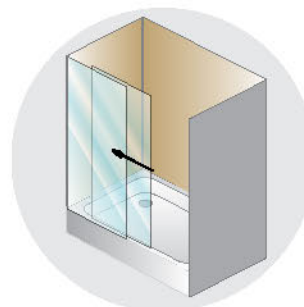

Kronos TV2D/S
160, 140, 120 - L

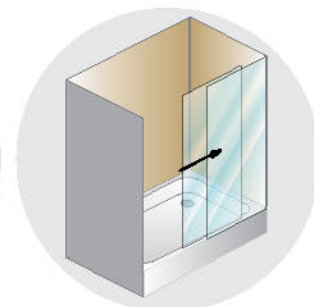

Kronos TV2D/S
160, 140, 120 - D



nanosan

Kronos NEWTV2D/S 120 - L, D

Kronos NEWTV2D/S 140 - L, D

Kronos NEWTV2D/S 160 - L, D



119 - 120

200

44



139 - 140

200

52



159 - 160

200

62



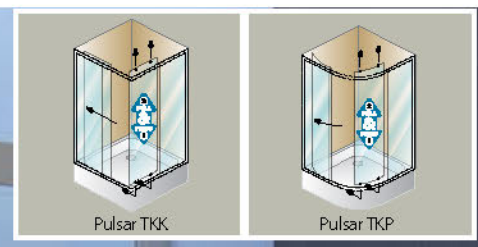

PULSAR

Pulsar

6 mm prozorno kaljeno steklo
6 mm kaljeno prozorno staklo
6 mm prozirno kaljeno staklo
6 mm átlátszó edzett üveg

1

6 mm master care kaljeno steklo
6 mm master care kaljeno staklo
6 mm master care kaljeno staklo
6 mm master care edzett üveg

2

Srebrni profili (srebrna galvanska prevleka)
Srebrni profili (srebrna galvanska prevleka)
Srebrni profili (srebrni galvanski premaz)
Ezüst profilok (fényezett ezüst galvanizált burkolat)

zapiranje z magnetnim profilom
zatvaranje s magnetskim profilom
zatvaranje pomoću magnetnog profila
zárás mágneses profillal

3

snemljiva vratna krila omogočajo lažje čiščenje
vratna krila na skidanje omogočuju lakše čiščenje
vratna krila sa mogućnošću skidanja omogućavaju lakše čišćenje
a könnyen leemelhető ajtószárnyak könnyed tisztítást tesznek lehetővé

4

spodnje demontažno vodilo
donja demontažna vodilica
donja demontažna vodíca
alsó kiszerelési konzol

5

nizek spodnji profil
nizak donji profil
nizak donji profil
alacsony alsóprofil

6

Pulsar



nanosan

Pulsar TKK 90

Pulsar TKK 100

Pulsar TKP 90

Pulsar TKP 100

88,5 - 90

98,5 - 100

88,5 - 90

98,5 - 100

200

200

200

200

49,5

51

57

57

55

55



Srebrna
Srebrna
Srebrna
Ezüst



Kaljeno prozorno steklo
Kaljeno prozirno staklo
Kaljeno providno staklo
Edzett átlátszó üveg



Kaljeno master care steklo
Kaljeno master care staklo
Kaljeno master care staklo
Edzett master care üveg



Vgradna mera
Ugradbena mjera
Ugradna mera
Beépítési méretek



Lerock zero,
Step zero,
Canary,
Haka,
Flamenco,
Rock,
Boston,
Trin,
Salsa,
Vals.



› 140-225 › 112-118 › 297 › 289-295 › 301 › 148

Kotna tuš kabina.

Snemljivi vratni krili na krogličnih ležajjih, ki omogočajo lažje čiščenje.
Kabina je primerna za tuš kadi:

Kutna tuš kabina.

Vratna krila na kugličnim ležajevima koja se mogu skidati i tako omogućavaju lakše čišćenje.
Kabina je primjerena za sljedeće tuš kade:

Ugaona tuš kabina.

Krila sa mogućnošću skidanja na kugličnim ležajevima koja omogućavaju lakše čišćenje.
Kabina je odgovarajuća za tuš kade:

Szögletes zuhanykabin.

Levehető ajtószárnyak golyóscsapágyakon, amelyek könnyebb tisztítást tesznek lehetővé.
A kabin a következő zuhanytálcákhoz ajánlott

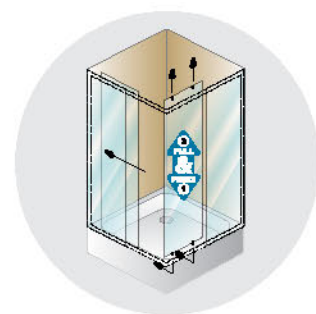

Pulsar TTK 90



88,5 - 90

200

49,5



Pulsar TTK 100



98,5 - 100

200

51





Eisa,
Macarena,
Blues,
Pony,
Bebop,
Dixie,
Ontex.



› 140-225 › 112-118 › 297 › 289-295 › 301 › 148

Polkrožna tuš kabina.

Šnemljivi vratni krili na krogličnih ležajjih, ki omogočajo lažje čiščenje. Kabina je primerna za tuš kadi:

Polukružna tuš kabina.

Vratna krila na kugličnim ležajevima koja se mogu skidati i tako omogućavaju lakše čiščenje. Kabina je primjerena za sljedeće tuš kade:

Polukružna tuš kabina.

Krila sa mogućnošću skidanja na kugličnim ležajevima koja omogućavaju lakše čiščenje. Kabina je odgovarajuća za tuš kade:

Félköríves zuhanykabin.

Levehető ajtószárnyak golyóscsapágyakon, amelyek könnyebb tisztítást tesznek lehetővé. A kabin a következő zuhanytálcákhoz ajánlott:

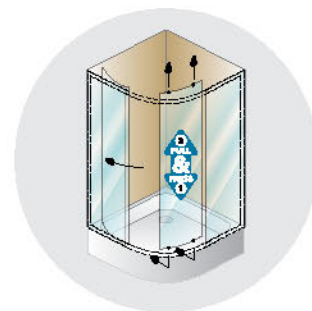

Pulsar TKP 90



88,5 - 90



Pulsar TKP 100



98,5 - 100



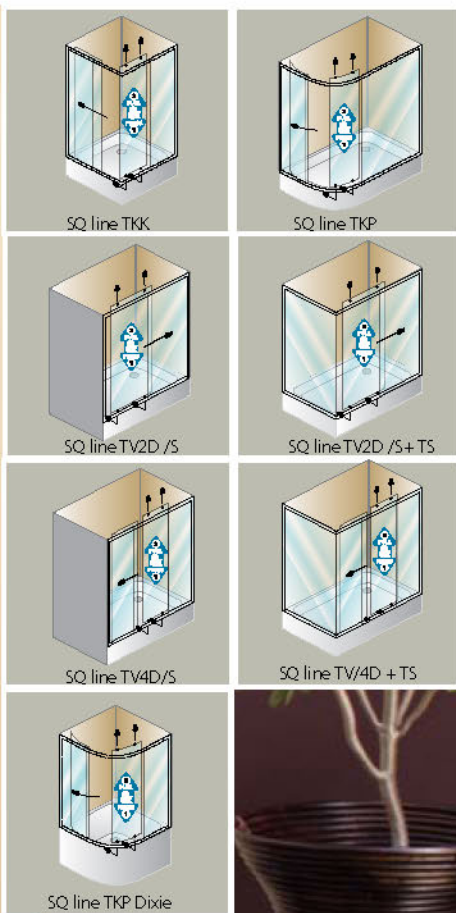
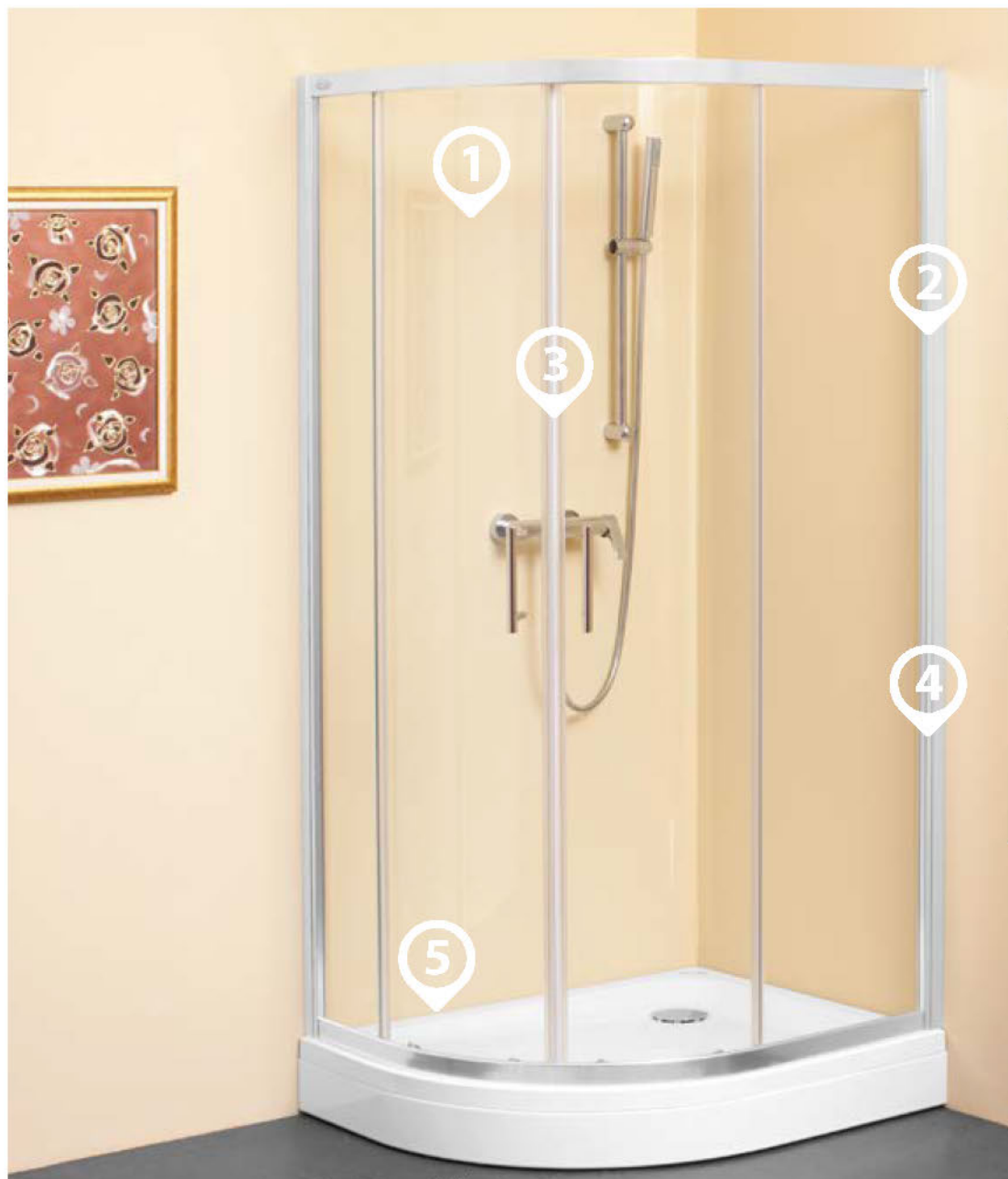

SQ line

SQ line											nano san
SQ line TKK 70						68 - 69,5 x 68 - 69,5	190	40			
SQ line TKK 80						78 - 79,5	190	42			
SQ line TKK 90						88 - 89,5	190	48			
SQ line TKK 100						98 - 99,5	190	58			
SQ line TKK 70x90						68 - 69,5 x 88 - 89,5	190	42			
SQ line TKK 75x90						73 - 74,5 x 88 - 89,5	190	42			
SQ line TKK 80x90						78 - 79,5 x 88 - 89,5	190	48			
SQ line TKK 80x100						78 - 79,5 x 98 - 99,5	190	50			
SQ line TKK 90x100						88 - 89,5 x 98 - 99,5	190	56			
SQ line TKP 80						78 - 79,5	190	42			55
SQ line TKP 90						88 - 89,5	190	52			55
SQ line TKP 100						98 - 99,5	190	52			55
SQ line TKP 80x100						78 - 79,5 x 98 - 99,5	190	49			55
SQ line TKP 90x120						88 - 89,5 x 118 - 119,5	190	53			55

Srebrna
 Srebrna
 Srebrna
 Ezüst

Bela
 Bijela
 Bela
 Fehér

Kaljeno prozorno staklo
 Kaljeno prizirno staklo
 Kaljeno providno staklo
 Edzett átlátszó üveg

Kaljeno chincilla staklo
 Kaljeno chincilla staklo
 Kaljeno chincilla staklo
 Öntött chincilla üveg

Vgradna mera
 Ugradbena mjera
 Ugradna mera
 Beépítési méretek

5/6 mm prozorno kaljeno steklo
5/6 mm kaljeno prozorno staklo
5/6 mm prozorno kaljeno staklo
5/6 mm átlátszó edzett üveg

1

5/6 mm chinchilla kaljeno steklo
5/6 mm chinchilla kaljeno staklo
5/6 mm chinchilla kaljeno staklo
5/6 mm chinchilla edzett üveg

2

Srebrni profili (srebrna galvanska prevleka)
Srebrni profili (srebrna galvanska prevlaka)
Srebrni profili (srebrni galvanski premaz)
Ezüst profilok (fényezett ezüst galvanizált burkolat)

Beli profili (prašno lakiranje)
Bijeli profili (plastificiranje)
Beli profili (lakiranje raspršivanjem)
Fehér profilok (porlakkozás)

zapiranje z magnetnim profilom
zatvaranje s magnetskim profilom
zatvaranje pomoću magnetnog profila
zárás mágneses profillal

3

možnost kompenzacijskih profilov
mogućnost kompenzacijskih profila
mogućnost kompenzacionih profila
annak lehetőségét, hogy kompenzációs pro-
filok

4



snemljiva vratna krila omogućavaju lakše čišćenje
vratna krila na skidanje omogućuju lakše čišćenje
vratna krila sa mogućnošću skidanja omogućavaju
lakše čišćenje
a könnyen leemelhető ajtószárnyak könnyed tisztítást
tesznek lehetővé

5

SQ line

SQ line TKP 90 Dixie

SQ line TV2D/S 100

SQ line TV2D/S 110

SQ line TV2D/S 120

SQ line TV2D/S 130

SQ line TV4D/S 140

SQ line TV4D/S 160

SQ line TV4D/S 170

SQ line TS 70 NEW

SQ line TS 75 NEW

SQ line TS 80 NEW

SQ line TS 90 NEW



Srebrna
Srebrna
Srebrna
Ezüst



Bela
Bijela
Bela
Fehér



Kaljeno prozorno steklo
Kaljeno prozorno staklo
Kaljeno providno staklo
Edzett átlátszó üveg



Kaljeno chinchilla steklo
Kaljeno chinchilla staklo
Kaljeno chinchilla staklo
Öntött chinchilla üveg



Vgradna mera
Ugradbena mjera
Ugradna mera
Beépítési méretek

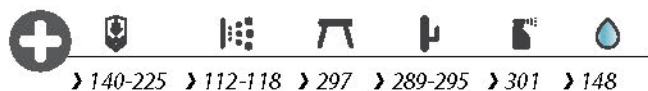
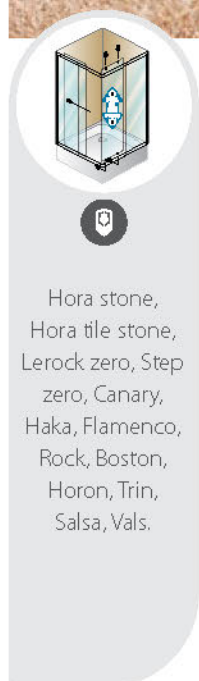

› 140-225 › 112-118 › 297 › 289-295 › 301 › 148

Kotna tuš kabina.

Snemljivi vratni krili na kugličnih ležajjih, ki omogočajo lažje čiščenje. Kabina je primerna za tuš kadi:

Kutna tuš kabina.

Vratna krila na kugličnim ležajevima koja se mogu skidati i tako omogućavaju lakše čišćenje. Kabina je primjerena za sljedeće tuš kade:

Ugaona tuš kabina.

Krila sa mogućnošću skidanja na kugličnim ležajevima koja omogućavaju lakše čišćenje. Kabina je odgovarajuća za tuš kade:

Szögletes zuhanykabin.

Levehető ajtószárnyak golyóscsapágyakon, amelyek könnyebb tisztítást tesznek lehetővé. A kabin a következő zuhanytálcákhoz ajánlott

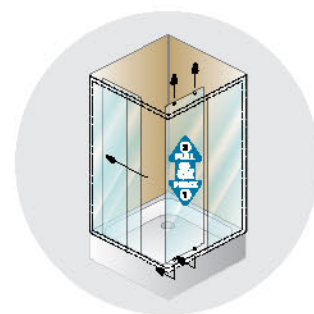

SQ line TKK 70				190	40	
SQ line TKK 80				190	42	
SQ line TKK 90				190	54	
SQ line TKK 100				190	58	
SQ line TKK 70 x 90				190	42	
SQ line TKK 75 x 90				190	42	
SQ line TKK 80 x 90				190	48	
SQ line TKK 80 x 100				190	50	
SQ line TKK 90 x 100				190	56	



Eisa,
Macarena,
Blues,
Pony,
Bebop,
Dixie,
Ontex.



> 140-225 > 112-118 > 297 > 289-295 > 301 > 148

Polkrožna tuš kabina.

Snemljivi vratni krili na kugličnih ležajjih, ki omogočajo lažje čiščenje.
Kabina je primerna za tuš kadi:

Polukružna tuš kabina.

Vratna krila na kugličnim ležajevima koja se mogu skidati i tako omogućavaju lakše čišćenje.
Kabina je primjerena za sljedeće tuš kade:

Polukružna tuš kabina.

Krila sa mogućnošću skidanja na kugličnim ležajevima koja omogućavaju lakše čišćenje.
Kabina je odgovarajuća za tuš kade:

Félköríves zuhanykabin.

Levehető ajtószárnyak golyóscsapágyakon, amelyek könnyebb tisztítást tesznek lehetővé.
A kabin a következő zuhanytálcákhoz ajánlott:

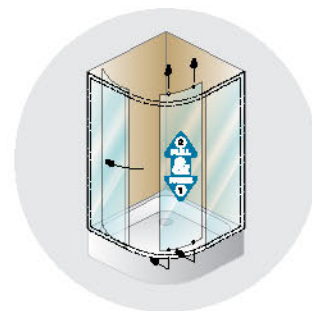

SQ line TKP 80					78 - 79,5	190	42	55	
SQ line TKP 90					88 - 89,5	190	52	55	
SQ line TKP 100					98 - 99,5	190	52	55	
SQ line TKP 80 x 100					78 - 79,5 x 98 - 99,5	190	49	55	
SQ line TKP 90 x 120					88 - 89,5 x 118 - 119,5	190	53	55	

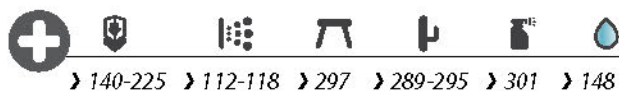
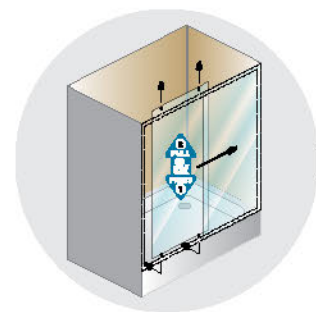
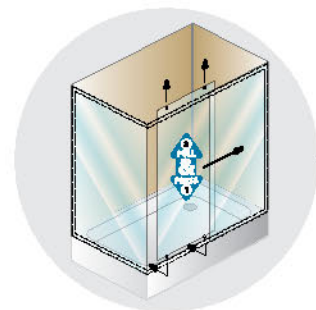
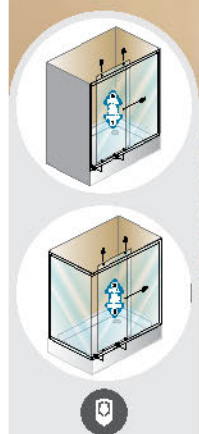

› 140-225 › 112-118 › 297 › 289-295 › 301 › 148

Dvodelna tuš vrata. Možnost montaže v nišo ali v kombinaciji s tuš steno.

Leva ali desna različica z obračanjem vrat ali stene. Snemljivi vratni krili na krogličnih ležajjih, ki omogočajo lažje čiščenje.

Vrata so primerna za tuš kadi:

Dvodijelna tuš-vrata. Možnost montaže u nišu ili u kombinaciji s tuš-stijenom.

Lijeva ili desna verzija s okretanjem vrata ili stijene. Vratna krila na kugličnim ležajevima koja se mogu skidati i tako omogućavaju lakše čišćenje.

Vrata su primjerena za sljedeće tuš kade:

Dvodelna tuš vrata. Možnost montaže u nišu ili u kombinaciji sa tuš zidom.

Leva ili desna varijanta sa okretanjem vrata ili zida. Krila sa mogućnošću skidanja na kugličnim ležajevima koja omogućavaju lakše čišćenje.

Vrata odgovarajuća za tuš kade:

Kétrészes zuhanykabinajtó csapágyon. Lehetséges a fülkébe szerelés, illetve zuhanyfallal kombinálva is. Baloldali és jobboldali változat az ajtó, vagy a fal forgatásával.

Balos- vagy jobbos beépítési lehetőség Variáció: az ajtó vagy a fal nyitásával.

Az ajtóhasználható zuhanykád esetében is:

SQ line TV2D/S 100					97 - 100	190	41				
SQ line TV2D/S 110					107,5 - 110	190	48				
SQ line TV2D/S 120					117,5 - 120	190	51				
SQ line TV2D/S 130					127,5 - 130	190	52				
SQ line TV2D/S + TS 70					68 - 70	190					
SQ line TV2D/S + TS 75					73 - 75	190					
SQ line TV2D/S + TS 80					78 - 80	190					
SQ line TV2D/S + TS 90					88 - 90	190					

Hora stone,
Hora tile stone,
Lerock zero, Step
zero, Canary,
Haka, Flamenco,
Rock, Boston,
Horon,
Vip, Salsa, Vals.

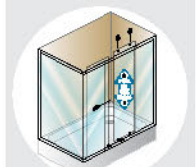
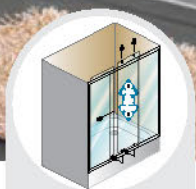

Bono,
Flamenco,
Salsa,
Canary.



› 140-225 › 112-118 › 297 › 289-295 › 301 › 148

Samostojna tuš vrata s sredinskim odpiranjem. Možnost montaže samostojno ali v kombinaciji s tuš steno. Snemljivi vratni krili na krogličnih ležajjih, ki omogočajo lažje čiščenje. Vrata so primerna za tuš kadi:

Samostalna tuš vrata sa središnjim otvaranjem. Mogućnost montaže samostalno ili u kombinaciji s tuš-stijenom. Vratna krila na skidanje na kugličnim ležajevima koji omogućuju lakše čišćenje. Vrata su primjerena za sljedeće tuš kade:

Tuš vrata sa centralnim otvaranjem. Mogućnost montaže samostalno ili u kombinaciji sa tuš zidom. Krila sa mogućnošću skidanja na kugličnim ležajevima koji omogućavaju lakše čišćenje. Vrata odgovarajuća za tuš kade:

Zuhanykabinajtó középű nyitással. Önálló beszerelés, vagy kombinálva zuhanyfallal.
Könnyen levehető ajtók golyóscsapágyon, a könnyebb tisztítás miatt.
Az ajtó megfordításával határozhatjuk meg a tolóajtó nyitásának irányát:

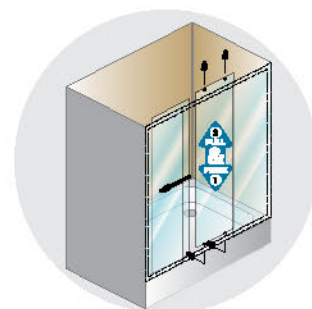
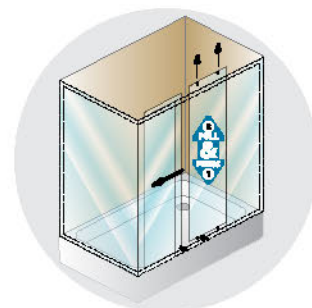

SQ line TV4D/S 140



SQ line TV4D/S 160



SQ line TV4D/S 170



SQ line TV4D/S + TS 70



SQ line TV4D/S + TS 75



SQ line TV4D/S + TS 80



SQ line TV4D/S + TS 90





Dixie.

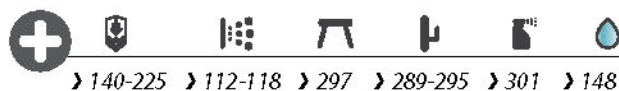

Polkrožna tuš kabina za tuš kad Dixie.

Snemljivi vratni krili na krogličnih ležajjih, ki omogočajo lažje čiščenje, h = 160.
Kabina je primerna za tuš kadi:

Polukružna tuš kabina za tuš kado Dixie.

Vratna krila na kugličnim ležajevima koja se mogu skidati i tako omogućavaju lakše čišćenje, h = 160.
Kabina je primjerena za sljedeće tuš kade:

Polukružna tuš kabina za tuš kado Dixie.

Krila sa mogućnošću skidanja na kugličnim ležajevima koja omogućavaju lakše čišćenje, h = 160.
Kabina je odgovarajuća za tuš kade:

Félköríves zuhanykabin zuhanytálcá Dixie.

Levehető ajtószármak golyóscsapágyakon, amelyek könnyebb tisztítást tesznek lehetővé, h = 160.
A kabin a következő zuhanytálcákhoz ajánlott:

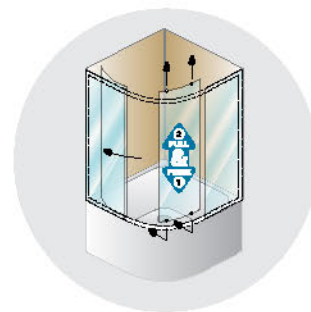

Izdelek je zelo primeren za starejše uporabnike.
Proizvod je vrlo primjeren za starije korisnike.
Proizvod je veoma adekvatan za starije korisnike
A termék megfelel az idősebb felhasználók igényeinek.

SQ line TKP 90 Dixie



88 - 89,5

160

52

55

Dodatni profili

Dodatni profili

Dodatni profili

Kiegészítő profilok

Različica z dodatnim profilom K 30
za TKK, TKP, TV2D, TV4D in TS.

Varijanta s dodatnim profilom K 30
za TKK, TKP, TV2D, TV4D i TS.

Varijanta sa dodatnim profilom K 30
za TKK, TKP, TV2D, TV4D i TS.

Variáció K 30 toldóprofilal
– TKK,TKP, TV2D, TV4D, TS -nél.

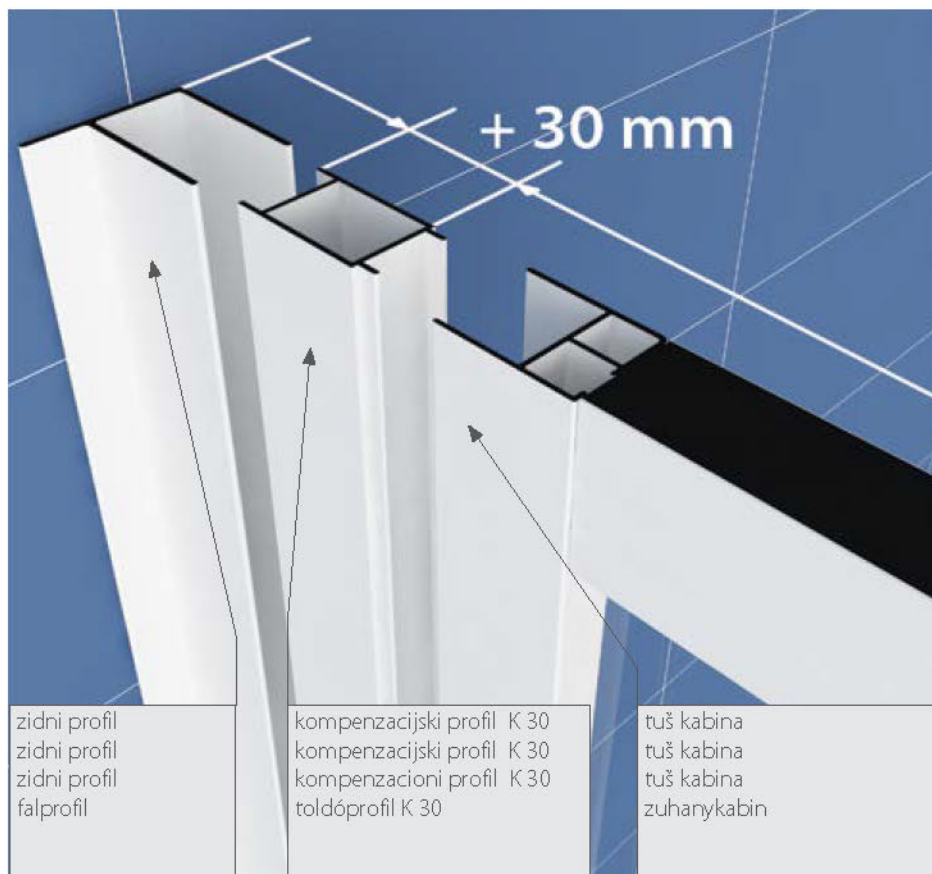

zidni profil
zidni profil
zidni profil
falprofil

kompenzacijski profil K 30
kompenzacijski profil K 30
kompenzacioni profil K 30
toldóprofil K 30

tuš kabina
tuš kabina
tuš kabina
zuhanykabin

Tip/Típus	Vrsta profila Profil típus		
K 30 SQ line	dodatni profil za TKK, TKP, TV2D, TV4D, TS SQ line kiegészítő profil TKK, TKP, TV2D, TV4D, TS típusokhoz SQ line	190	3,0

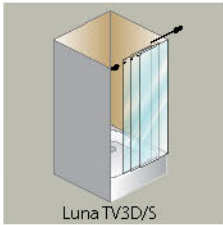
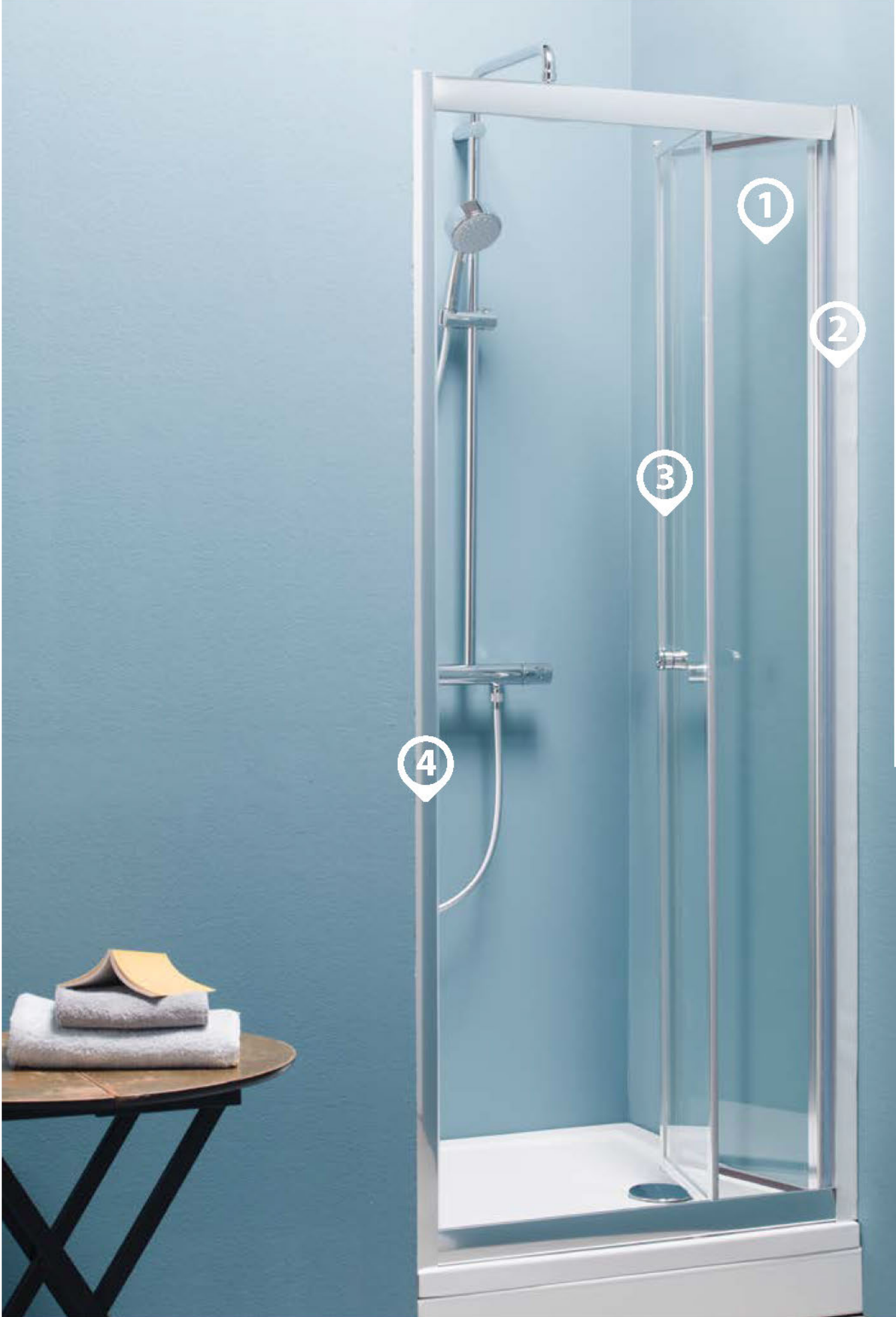

Luna TV3D/S



Luna TV3D/S + TSV3D



Luna TVZ/S



Luna TVZ/S + TSvZ

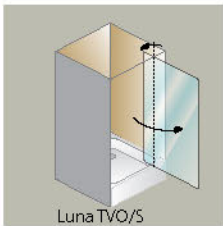

Luna TVO/S

LUNA

Luna



4 mm prozorno kaljeno steklo
4 mm kaljeno prozirno staklo
4 mm prozimo kaljeno staklo
4 mm átlátszó edzett üveg

1

4 mm chinchilla kaljeno steklo
4 mm chinchilla kaljeno staklo
4 mm chinchilla kaljeno staklo
4 mm chinchilla edzett üveg

2

Srebrni profil (srebrna galvanska prevleka)
Srebrni profil (srebrna galvanska prevleka)
Srebrni profil (srebrni galvanski premaz)
Ezüst profilok (fényezett ezüst galvanizált burkolat)









































zapiranje z magnetnim profilom
zatvaranje s magnetskim profilom
zatvaranje pomoću magnetnog profila
zárás mágneses profillal

3

možnost kompenzacijskega profila K 30 – za TV3D/S, TVZ/S
mogućnost kompenzacijskog profila K 30 – za TV3D/S, TVZ/S
mogućnost kompenzatornog profila K 30 – za TV3D/S, TVZ/S
a lehetőségét, kompenzációs profil K 30 – TV3D/S, TVZ/S -nél.

4

možnost kompenzacijskega profila K 25 – za TVO/S
mogućnost kompenzacijskog profila K 25 – za TVO/S
mogućnost kompenzatornog profila K 25 – za TVO/S
a lehetőségét, kompenzációs profil K 25 – TVO/S -nél.

Luna			A 	B 					nanosan
Luna TV3D/S 80			78 - 80		185	37			
Luna TV3D/S 90			88 - 90		185	43			
Luna TV3D/S 100			98 - 100		185	50			
Luna TSv3D 80			78 - 80		185				
Luna TSv3D 90			88 - 90		185				
Luna TSvZ 80			78 - 80		185				
Luna TSvZ 90			88 - 90		185				
Luna TVZ/S 80			78 - 80	78 - 80	185	57			
Luna TVZ/S 90			88 - 90	88 - 90	185	67			
Luna TVO/S 80			78 - 80		190	53			
Luna TVO/S 90			88 - 90		190	63			

Srebrna
Srebrna
Srebrna
Ezüst

Kaljeno prozorno steklo
Kaljeno prozirno staklo
Kaljeno providno staklo
Edzett átlátszó üveg

Kaljeno chinchilla steklo
Kaljeno chinchilla staklo
Kaljeno chinchilla staklo
Öntött chinchilla üveg

Ygradna mera
Ugradbena mjera
Ugradna mera
Beépítési méretek



Hora stone,
Hora tile stone,
Lerock zero,
Canary, Haka,
Flamenco,
Rock, Boston,
Trin, Bono,
Vip, Salsa,
Vals.



› 140-225 › 112-118 › 297 › 289-295 › 301 › 148

Samostojna tuš vrata, tridelna.

Možnost vgradnje dodatnega profila K 25 za izvedbo nestandardnih dimenzij kabin po širini.

Vrata so primerna za tuš kadi:

Samostalna tuš vrata, tridelna.

Mogućnost ugradnje dodatnog profila K 25 za izvedbu nestandardnih dimenzija kabina po širini.

Vrata su primjerena za sljedeće tuš kade:

Samostalna tuš vrata, tridelna.

Mogućnost ugradnje dodatnog profila K 25 za izvedbu nestandardnih dimenzija kabina po širini. Vrata odgovarajuća za tuš kade:

Önálló zuhanyajtó, háromrészes.

Kiegészítő K 25-ös profil beépítésének lehetősége nem szabványos kabinszélességek esetében.



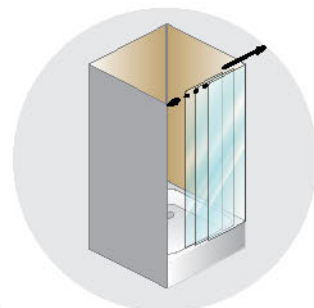



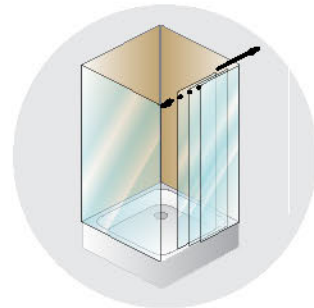

























Az ajtó a következő zuhanytálcákhoz ajánlott:



Luna TV3D/S



Luna TV3D/S + TSv3D

								
Luna TV3D/S 80			78 - 80	185	37			
Luna TV3D/S 90			88 - 90	185	43			
Luna TSv3D/S 100			88 - 90	185	50			
Luna TSv3D 80			78 - 80	185				
Luna TSv3D 90			88 - 90	185				



Hora stone,
Hora tile stone,
Lerock zero,
Canary, Haka,
Flamenco,
Rock, Boston,
Trin, Bono,
Vip, Salsa,
Vals.



› 140-225 › 112-118 › 297 › 289-295 › 301 › 148

Samostojna tuš vrata z zložljivima kriloma. Možnost vgradnje dodatnega profila K 30 za izvedbo nestandardnih dimenzij kabin po širini. Vrata so primerna za tuš kadi:

Samostalna tuš vrata preklopna. Mogućnost ugradnje dodatnog profila K 30 za izvedbu nestandardnih dimenzija kabina po širini. Vrata su primjerena za sljedeće tuš kade:

Samostalna tuš vrata sa sklopivim krilima. Mogućnost ugradnje dodatnog profila K 30 za izvođenje nestandardnih dimenzija kabina po širini. Vrata odgovarajuća za tuš kade:

Önálló zuhanyajtó összerakható szárnyakkal. Kiegészítő K 30-as profil beépítésének lehetősége nem szabványos kabinszélességek esetében.

Az ajtó a következő zuhanytálcákhoz ajánlott:



Luna TVZ/S



Luna TVZ/S + TSvZ



Luna TVZ/S 80



78 - 80

185

57



Luna TVZ/S 90



88 - 90

185

67



Luna TSvZ 80



78 - 80

185



Luna TSvZ 90



88 - 90

185



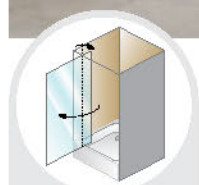

Hora stone,
Hora tile stone,
Lerock zero,
Canary, Haka,
Flamenco,
Rock, Boston,
Trin, Bono,
Vip, Salsa,
Vals.



› 140-225 › 112-118 › 297 › 289-295 › 301 › 148

Samostojna tuš vrata, obračalna.

Možnost vgradnje dodatnega profila K 25 za izvedbo nestandardnih dimenzij kabin po širini.

Vrata so primerna za tuš kadi:

Tuš kabina, okretljiva.

Mogućnost ugradnje dodatnog profila K 25 za izvedbu nestandardnih dimenzija kabina po širini.

Vrata su primjerena za sljedeće tuš kade:

Tuš kabina, okretna.

Mogućnost ugradnje dodatnog profila K 25 za izvedbu nestandardnih dimenzija kabina po širini.

Vrata odgovarajuća za tuš kade:

Zuhanykabin, forgatható.

Kiegészítő K 25-ös profil beépítésének lehetősége nem szabványos kabinszélességek esetében.

Az ajtó a következő zuhanytálcákhoz ajánlott:

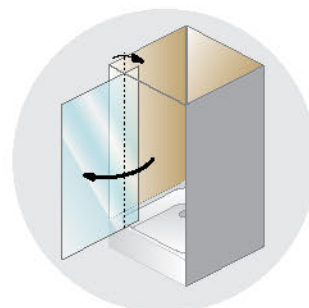
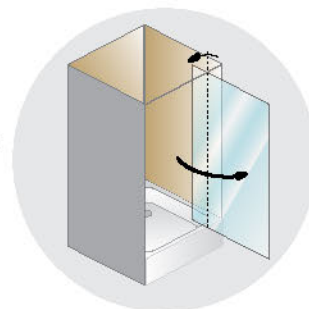

Luna TVO/S

Luna TVO/S 80			78 - 80	190	53			
Luna TVO/S 90			88 - 90	190	63			

Dodatni profili

Dodatni profili

Dodatni profili

Kiegészítő profilok

Dodatni profil za izvedbo nestandardnih dimenzij kabin po širini.

Različica s kompenzacijskim profilom K 30
– za TV3D/S, TVZ/S

Dodatni profil za podešavanje izvan-standardnih dimenzija kabina po širini.

Varijanta s kompenzacijskim profilom K 30
– za TV3D/S, TVZ/S

Dodatni profil za izvedbu nestandardnih dimenzija kabina po širini.

Varijanta sa kompenzacionim profilom K 30
– za TV3D/S, TVZ/S

A kiegészítő profilok a szabványon kívüli szélességű kabinok szereléséhez alkalmasak.

Variáció K 30 toldóprofilal
– TV3D/S, TVZ/S -nél.

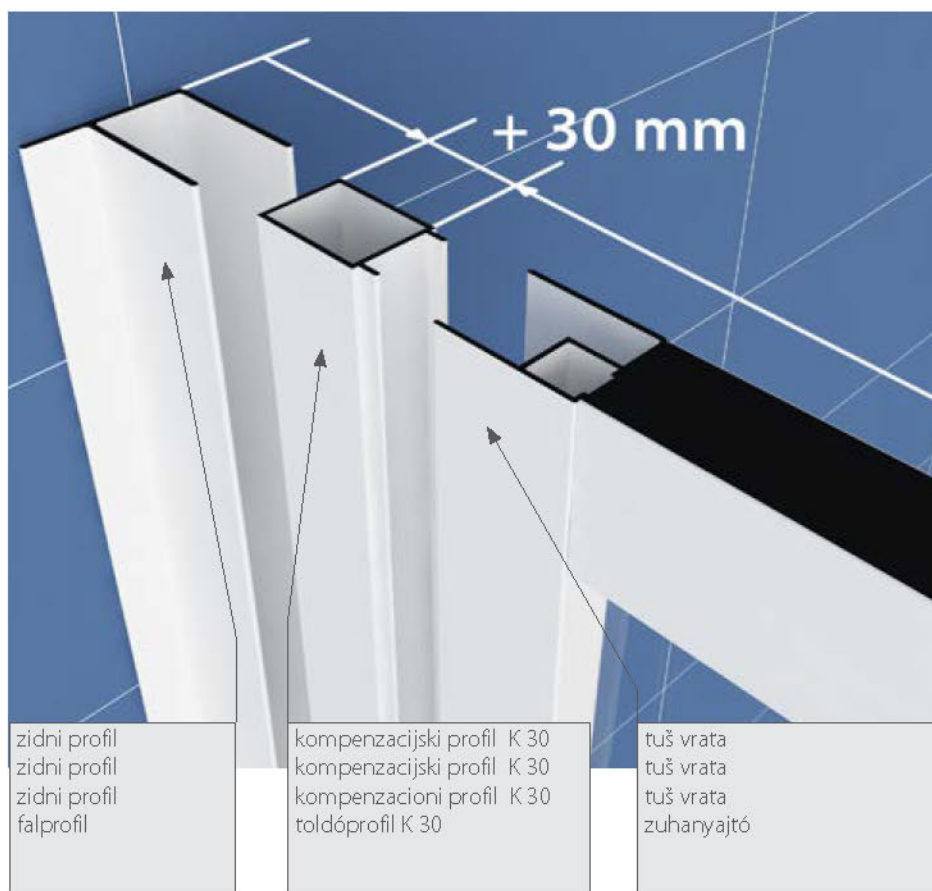

zidni profil
zidni profil
zidni profil
falprofil

kompenzacijski profil K 30
kompenzacijski profil K 30
kompenzacioni profil K 30
toldóprofil K 30

tuš vrata
tuš vrata
tuš vrata
zuhanyajtó

Dodatni profil za izvedbu nestandardnih dimenzij kabin po širini.

Različica s kompenzacijskim profilom K 25
– za TVO/S

Dodatni profil za podešavanje izvan-standardnih dimenzija kabina po širini.

Varijanta s kompenzacijskim profilom K 25
– za TVO/S

Dodatni profil za izvedbu nestandardnih dimenzija kabina po širini.

Varijanta sa kompenzacionim profilom K 25
– za TVO/S

A kiegészítő profilok a szabványon kívüli szélességű kabinok szereléséhez alkalmasak.

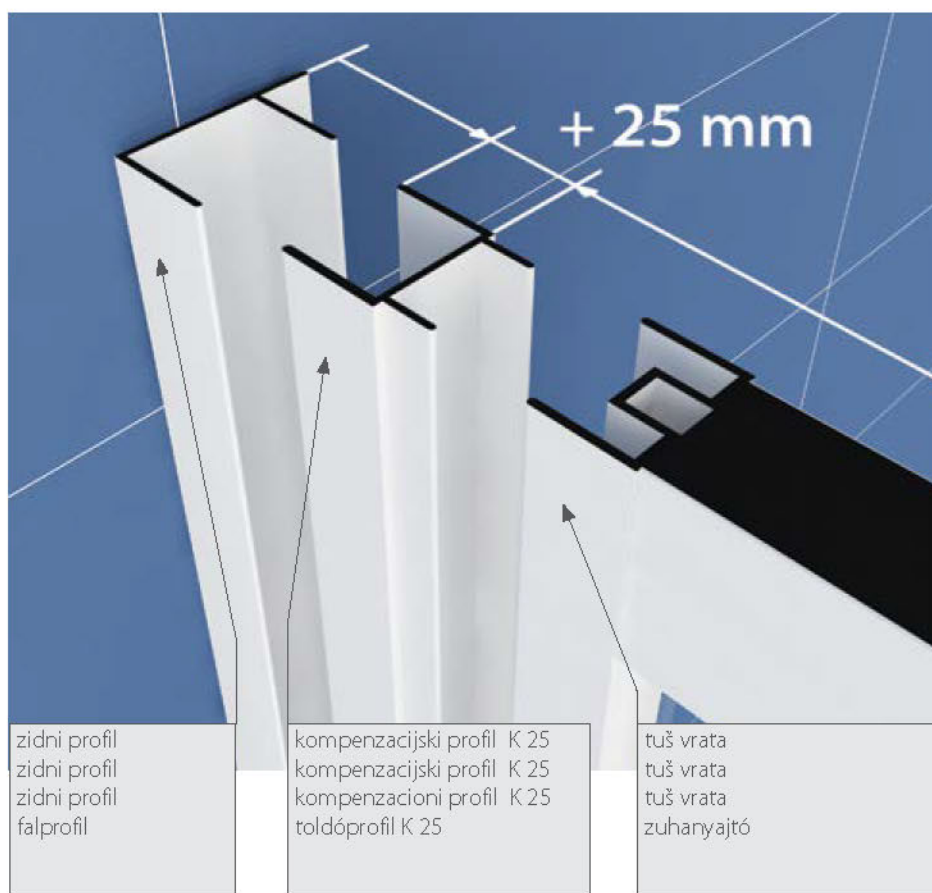

Variáció K 25 toldóprofilal
– TVO/S -nél.



zidni profil
zidni profil
zidni profil
falprofil

kompenzacijski profil K 25
kompenzacijski profil K 25
kompenzacioni profil K 25
toldóprofil K 25

tuš vrata
tuš vrata
tuš vrata
zuhanyajtó

Tip/Típus	Vrsta profila Profil típus		
K 30 - TV3D/S, TVZ/S	dodatni profil za TV3D/S, TVZ/S kiegészítő profil TV3D/S, TVZ/S típushoz	185	3,0
K 25 - TVO/S	dodatni profil za TVO/S kiegészítő profil TVO/S típushoz	185	2,5

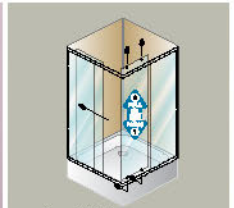

Quat.TKK

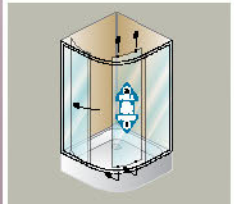

Quat.TKP

ECO QUAT

Eco Quat

5 mm prozorno kaljeno steklo
 5 mm kaljeno prozirno staklo
 5 mm prozimo kaljeno staklo
 5 mm átlátszó edzett üveg

1

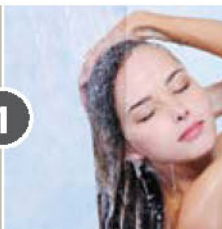

Srebrni profili (srebrna galvanska prevleka)
 Srebrni profili (srebrna galvanska prevlaka)
 Srebrni profili (srebrni galvanski premaz)
 Ezüst profilok (fényezett ezüst galvanizált burkolat)

2



zapiranje z magnetnim profilom
 zatvaranje s magnetskim profilom
 zatvaranje pomoću magnetnog profila
 zárás mágneses profillal

3

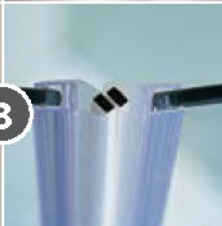





















snemljiva vratna krila omogočajo lažje čiščenje
 vratna krila na skidanje omogočuju lakše čiščenje
 vratna krila sa mogućnošću skidanja omogućavaju lakše čiščenje
 a könnyen leemelhető ajtószárnyak könnyed tisztítást tesznek lehetővé

4



Eco Quat

Eco Quat									nanosan
Eco Quat TKK 80			77,5 - 78	185	41				
Eco Quat TKK 90			87,5 - 88	185	45				
Eco Quat TKP 80			78 - 78,5	185	45		55		
Eco Quat TKP 90			88 - 88,5	185	57		55		



Srebrna
 Srebrna
 Srebrna
 Ezüst



Kaljeno prozorno steklo
 Kaljeno prozirno staklo
 Kaljeno prozorno staklo
 Edzett átlátszó üveg



Ygradna mera
 Ugradbena mjera
 Ugradna mera
 Beépítési méretek



Hora stone,
Hora tile stone,
Lerock zero,
Canary, Haka,
Flamenco,
Rock, Boston,
Trin, Bono,
Vip, Salsa,
Vals.



› 140-225 › 112-118 › 297 › 289-295 › 301 › 148

Kotna tuš kabina.

Snemljivi vratni krili na krogličnih ležajjih, ki omogočajo lažje čiščenje.
Kotna kabina je primerna za tuš kadi:

Kutna tuš kabina i stjenka za tuš kadu.

Vratna krila na kugličnim ležajevima koja se mogu skidati i tako omogućavaju lakše čiščenje.
Kabina primjerena za sljedeće tuš kade:

Ugaona tuš kabina i tuš zid.

Krila sa mogućnošću skidanja na kugličnim ležajevima koja omogućavaju lakše čiščenje.
Kabina je odgovarajuća za tuš kade:

Szögletes zuhanykabin.

Levehető ajtószárnyak golyóscsapágyakon, amelyek könnyebb tisztítást tesznek lehetővé.
A kabin a következő zuhanytálcákhoz ajánlott:

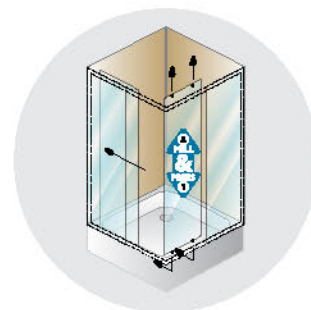

Eco Quat TKK



Eco Quat TKK 80



78 - 78,5

185

45



Eco Quat TKK 90



88 - 88,5

185

57





Eisa,
Macarena,
Blues,
Pony,
Bebop,
Dixie,
Ontex.



› 140-225 › 112-118 › 297 › 289-295 › 301 › 148

Polkružna tuš kabina.

Snemljivi vratni krili na krogličnih ležajjih, ki omogočajo lažje čiščenje.

Zapiranje (tesnjenje) z magnetnim profilom.

Kabina je primerna za tuš kadi:

Polukružna tuš kabina.

Vratna krila na kugličnim ležajevima koja se mogu skidati i tako omogućavaju

lakše čišćenje. Zatvaranje (brtvljenje) pomoću magnetskog profila.

Kabina primjerena za sljedeće tuš kade:

Polukružna tuš kabina.

Krila sa mogućnošću skidanja na kugličnim ležajevima koja omogućavaju

lakše čišćenje. Zatvaranje (zaptivanje) pomoću magnetnih profila.

Kabina je odgovarajuća za tuš kade:

Félköríves zuhanykabin.

Levehető ajtószárnyak golyóscsapágyakon, amelyek könnyebb tisztítást

tesznek lehetővé. Zárás mágneses profillokkal.

A kabin a következő zuhanytálcákhoz ajánlott

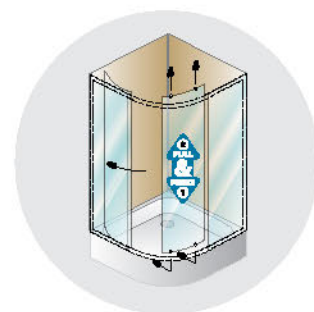

Eco Quat TKP



Eco Quat TKP 80



77,5 - 78

185

41



Eco Quat TKP 90



87,5 - 88

185

45



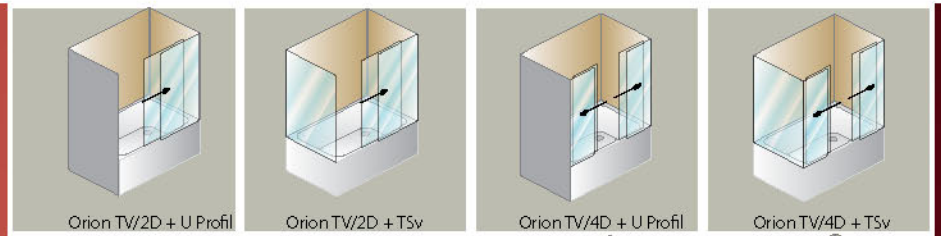

ORION

Orion

6 mm prozorno kaljeno steklo
6 mm kaljeno prozorno staklo
6 mm prozorno kaljeno staklo
6 mm átlátszó edzett üveg

1

6 mm chinchilla kaljeno steklo
6 mm chinchilla kaljeno staklo
6 mm chinchilla kaljeno staklo
6 mm chinchilla edzett üveg

2







































Srebrni profilni (srebrna galvanska prevleka)
Srebrni profilni (srebrna galvanska prevleka)
Srebrni profilni (srebrni galvanski premaz)
Ezüst profilok (fényezett ezüst galvanizált burkolat)

zapiranje z magnetnim profilom
zatvaranje s magnetskim profilom
zatvaranje pomoću magnetnog profila
zárás mágneses profillal

3

možnost kompenzacijskega profila K 35
mogućnost kompenzacijskog profila K 35
mogućnost kompenzatornog profila K 35
a lehetőséget, kompenzációs profil K 35

4

Orion									nanosan
Orion TV/2D 120			118 - 120	140	48				
Orion TV/2D 130			128 - 130	140	52				
Orion TV/4D 140			138 - 140	140	55				
Orion TV/4D 150			148 - 150	140	55				
Orion TV/4D 160			158 - 160	140	66				
Orion TV/4D 170			168 - 170	140	73				
Orion TV/4D 180			178 - 180	140	73				
Orion TSv 70			68 - 71	140					
Orion TSv 75			73 - 76	140					
Orion TSv 80			78 - 81	140					

Srebrna
Srebrna
Srebrna
Ezüst

Kaljeno prozorno steklo
Kaljeno prozorno staklo
Kaljeno prozorno staklo
Edzett átlátszó üveg

Kaljeno chinchilla steklo
Kaljeno čincila staklo
Kaljeno čincila staklo
Edzett chinchilla üveg

Vgradna mera
Ugradbena mjera
Ugradna mera
Beépítési méretek

120 >
>130120 >
>130

› 140-225 › 112-118 › 297 › 289-295 › 301 › 148

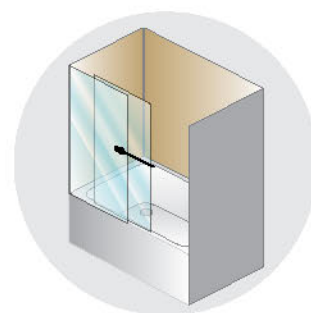

Orion TV/2D

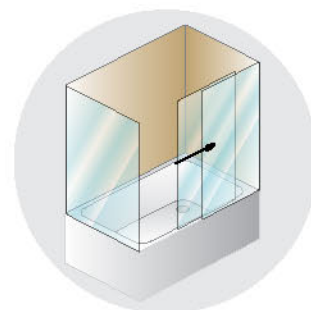

Orion TV/2D + TSv

Dvodelna vrata za kopalno kad. Možnost montaže v nišo ali v kombinacije s tuš-stijeno.

Možnost vgradnje tudi samostojno v zidno nišo skupaj z U-profilom. Možnost vgradnje dodatnega profila K 35 za izvedbo nestandardnih dimenzij kabin po širini. Leva ali desna različica z obračanjem vrat.

Dvodielna vrata za kupaoničku kadu. Mogućnost montaže u nišu ili u kombinaciji s tuš-stijenom.

Mogućnost ugradnje i samostalno u zidnu nišu zajedno s U-profilom. Mogućnost ugradnje dodatnog profila K 35 za izvedbu nestandardnih dimenzija kabina po širini. Lijeva ili desna verzija s okretanjem vrata.

Dvodelna vrata za kadu za kupanje. Mogućnost montaže u nišu ili u kombinaciji sa tuš zidom.

Mogućnost ugradnje i samostalno u zidnu nišu zajedno sa U-profilom. Mogućnost ugradnje dodatnog profila K 35 za izvedbu nestandardnih dimenzija kabina po širini. Leva ili desna varijanta sa okretanjem vrata.

Kétrészes ajtó fürdőkádra. Önálló beszerelés, vagy kombinálva zuhanyfallal.

Lehetséges az önálló beszerelés falfülkébe U-profillal. Lehetséges a kiegészítő K 35 profilos beszerelés a szabványoknál nagyobb, szélesebb kabinok esetében. Baloldali és jobboldali változat ajtóforgatással.

Orion TV/2D 120 + U-profil				118 - 120	140	48		
Orion TV/2D 130 + U-profil				128 - 130	140	52		
Orion TV/2D 120 + TSv 80, 75, 70				118 - 120	140	48	55	
Orion TV/2D 130 + TSv 80, 75, 70				128 - 130	140	52	55	



140 >
>168



> 140-225 > 112-118 > 297 > 289-295 > 301 > 148

Tuš vrata s sredinskim odpiranjem za kopalno kad. Možnost vgradnje samostojno v zidno nišo skupaj z U-profilom ali v kombinaciji s tuš steno. Možnost vgradnje dodatnega profila K 35 za izvedbo nestandardnih dimenzij kabin po širini. Vratna krila so na ležajih in se odpirajo levo in desno.



140 >
>168

Vrata tuša s otvaranjem po sredini za kupaoničku kadu. Mogućnost ugradnje samostalno u zidnu nišu zajedno s U-profilom ili u kombinaciji s tuš-stijenom. Mogućnost ugradnje dodatnog profila K 35 za izvedbu nestandardnih dimenzija kabina po širini. Vratna krila su na ležajevima i otvaraju se lijevo i desno.

Tuš vrata sa centralnim otvaranjem za kadu za kupanje. Mogućnost ugradnje samostalno u zidnu nišu zajedno sa U-profilom ili u kombinaciji sa tuš zidom. Mogućnost ugradnje dodatnog profila K 35 za izvedbu nestandardnih dimenzija kabina po širini. Vratna krila su na šarkama i otvaraju se levo i desno.

Zuhanykabinajtó középső nyitással fürdőkádakra. Lehetséges az önálló beszerelés falfülkébe U-profillal vagy kombinálva zuhanyfallal. Lehetséges a kiegészítő K 35 profilos beszerelés a szabványoknál nagyobb, szélesebb kabinok esetében. Az ajtószárnyak csapágyakon, balra és jobbra is nyithatók.

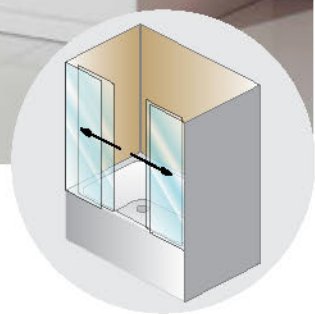

Orion TV/4D

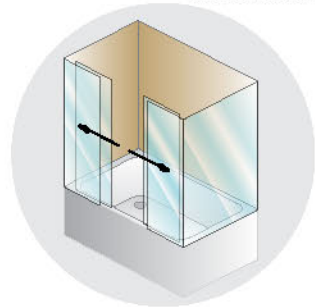

Orion TV/4D + TSv

Orion TV/2D 140 + U-profil				138 - 140	140	55			
Orion TV/2D 150 + U-profil				148 - 150	140	55			
Orion TV/2D 160 + U-profil				158 - 160	140	66			
Orion TV/2D 170 + U-profil				168 - 170	140	73			
Orion TV/2D 180 + U-profil				178 - 180	140	73			
Orion TV/4D 140 + TSv 70, 75, 80				138 - 140	140	55			
Orion TV/4D 150 + TSv 70, 75, 80				148 - 150	140	55			
Orion TV/4D 160 + TSv 70, 75, 80				158 - 160	140	66			
Orion TV/4D 170 + TSv 70, 75, 80				168 - 170	140	73			
Orion TV/4D 180 + TSv 70, 75, 80				178 - 180	140	73			

Dodatni profili

Dodatni profili

Dodatni profili

Kiegészítő profilok

Dodatni profil za izvedbo nestandardnih dimenzij kabin po širini.

Različica z dodatnim profilom K 35 za TV/2D in TV/4D.

Dodatni profil za podešavanje izvan-standardnih dimenzija kabina po širini.

Varijanta s dodatnim profilom K 35 za TV/2D i TV/4D.





Dodatni profil za izvedbu nestandardnih dimenzija kabina po širini.

Varijanta s dodatnim profilom K 35 za TV/2D i TV/4D.

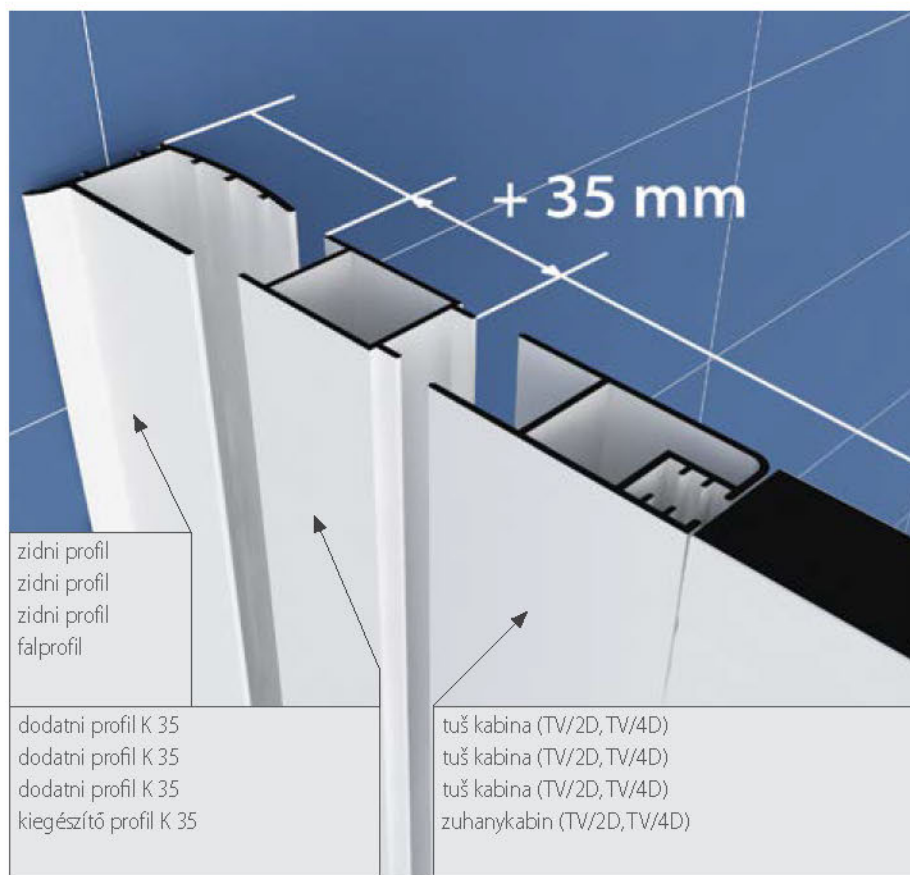
A kiegészítő profilok a szabványon kívüli szélességű kabinok szereléséhez alkalmasak.

Variáció K 35 toldóprofilal – TV/2D,TV/4D -nél.



Tip / Típus	Vrsta profila Profilítípus			
	 			
K 35	dodatni profil za TV/2D, TV/4D dodatni profil za TV/2D, TV/4D dodatni profil za TV/2D, TV/4D kiegészítő profil TV/2D, TV/4D típushoz	140	3,5	



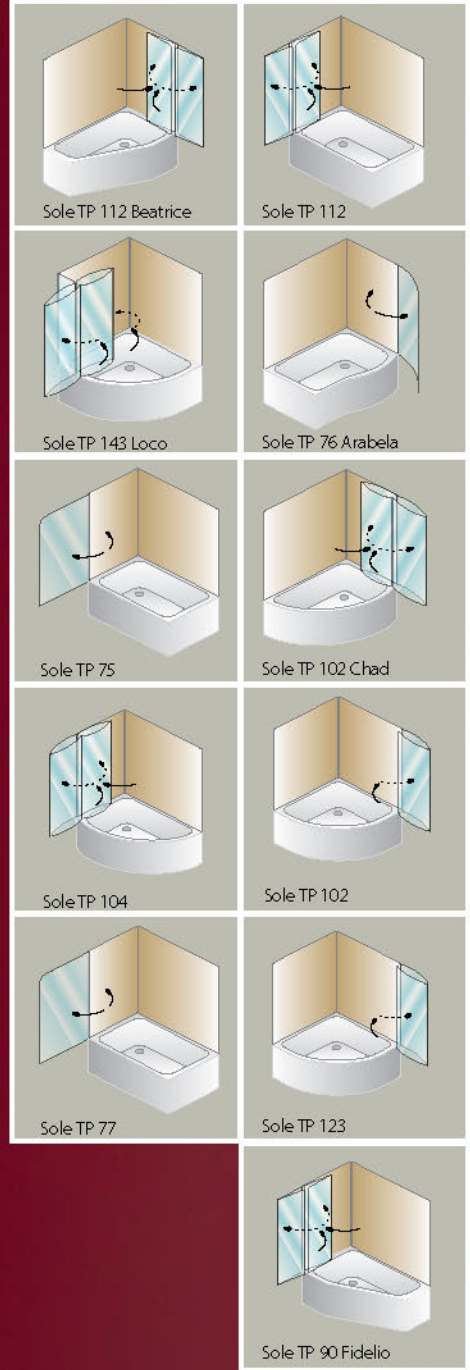

SOLE

Sole

6 mm prozorno kaljeno steklo
6 mm kaljeno prozorno staklo
6 mm prozorno kaljeno staklo
6 mm átlátszó edzett üveg

6 mm satinirano kaljeno steklo
6 mm kaljeno satinirano staklo
6 mm satinirano kaljeno staklo
6 mm szatén edzett üveg

6 mm chinchilla kaljeno steklo
6 mm chinchilla kaljeno staklo
6 mm chinchilla kaljeno staklo
6 mm chinchilla edzett üveg

Srebrni profili (srebrna galvanska prevleka)
Srebrni profili (srebrna galvanska prevleka)
Srebrni profili (srebrni galvanski premaz)
Ezüst profilok (fényezett ezüst galvanizált burkolat)











































































Beli profili (prašno lakiranje)
Bijeli profili (plastificiranje)
Beli profili (lakiranje raspršivanjem)
Fehér profilok (porlakkozás)

Kromirana opora (Ø 15, dužina=52cm) za stabilizaciju stekla za: TP 75, TP 102, TP 104, TP 112, TP 123
Kromirana podrška (Ø 15, dužina=52cm) za stabilizaciju stakla za: TP 75, TP 102, TP 104, TP 112, TP 123
Hromirana podrška (Ø 15, dužina=52cm) za stabilizaciju stakla za: TP 75, TP 102, TP 104, TP 112, TP 123
Kromozott támasztóelem (Ø 15, hossz=52cm) az üveg stabilizációjához: TP 75, TP 102, TP 104, TP 112, TP 123

1

2

3

Sole									nanosan
Sole TP 75					140	75			
Sole TP 77					140	76 - 77			
Sole TP 80 Arabela -L,-D					155	80			
Sole TP 90 Fidelio -L,-D					140	90			
Sole TP 112 -L,-D					140	112 - 113			
Sole TP 112 Beatrice -L,-D					140	112 - 113			
Sole TP 102 Allegro, Royal, Divante -L,-D					140	102			
Sole TP 102 Chad -L,-D					140	102			
Sole TP 104 Lulu, Calando -L,-D					140	104			
Sole TP 123 Orfeo, Largo, Alba -L,-D					140	123			
Sole TP 143 Loco -L,-D					140	143			



Bela
Bijela
Bela
Fehér



Srebrna
Srebrna
Srebrna
Ezüst



Kaljeno prozorno steklo
Kaljeno prozorno staklo
Kaljeno providno staklo
Edzett átlátszó üveg



Kaljeno satinirano steklo
Kaljeno satinirano staklo
Mat kaljeno staklo (satinirano)
Öntött szatínált üveg



Kaljeno chinchilla steklo
Kaljeno činčila staklo
Kaljeno činčila staklo
Edzett chinchilla üveg



Vgradna mera
Ugradbena mjera
Ugradna mera
Beépítési méretek

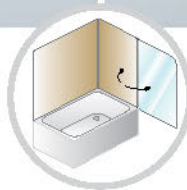

Enodelni krilni zaslon za kopalne kadi na obračalnem zidnem profilu.

Možnost montaže levo ali desno.

Zaslon je namenjen kopalnim kadem vseh dolžin.



› 140-225 › 112-118 › 297 › 289-295 › 301 › 148

Jednodijelni krilni paravan za kupaonske kade na zidnem profilu na okretanje.

Mogućnost montaže lijevo i desno.

Paravan je primjeren za kupaonske kade svih dužina.

Jednodijelni tuš paravan na zidnom profilu koji se okreće.

Mogućnost montaže levo ili desno.

Tuš paravan je namenjen za kade svih dužina.



- Opora stakla za TP (tp 75,102,104,112,123)
- Držać stakla za TP (tp 75,102,104,112,123)
- Potpora stakla za TP (tp 75102,104,112,123)
- Üvegfal támasz TP (tp 75,102,104,112,123)

Egyoldalú kádparaván fürdőkádakhoz forgatható falprofilal.

Bal- vagy jobb beépítési lehetőség.

A paraván minden méretű fürdőkádra szerelhető.



Sole TP 75, 77 - L

Sole TP 75, 77 - D

● OPCIE / OPCJE / OPCJE / OPCÍOK :

									nanosan
Sole TP 75				140	75				
Sole TP 77				140	77				



Dvodelni krilni zaslon za kopalne kade na obračalnem zidnem profilu.

Zaslon je namenjen ravnim kopalnim kadem vseh dolžin. Prvo krilo na tečajjih, preklopno na zunanjo stran, obe krili sta zložljivi na notranjo ali zunanjo stran.

Dvodijelni krilni paravan za kupaonske kade na zidnom profilu na okretanje.

Namjena paravana je za ravne kupaonske kade svih dužina. Prvo krilo je na šarkama koje se preklapaju na vanjsku stranu. Oba krila se mogu sklopiti na vanjsku i unutarnju stranu.

Dvodelni tuš paravan na zidnom profilu koji se okreće.

Tuš paravan je namenjen za ravne kade svih dužina.

Prvo krilo je na šarkama, drugo se preklapa na spoljašnju, a oba su sklopiva na unutrašnju ili spoljašnju stranu.

Kétrészes kádparaván fürdőkádákhoz forgatható falprofilal.

A paraván minden méretű fürdőkádra szerelhető. Az első szárny zsanérokon elfordítható a külső oldalra, mindkét szárny összecukható a belső vagy a külső oldalra.



> 140-225 > 112-118 > 297 > 289-295 > 301 > 148



- Opora stekla za TP (tp 75,102,104,112,123)
- Držač stakla za TP (tp 75,102,104,112,123)
- Potpora stakla za TP (tp 75102,104,112,123)
- Üvegfal támasz TP (tp 75,102,104,112,123)



Sole TP 112 - L

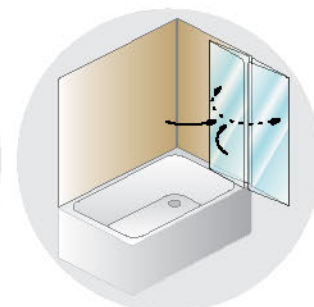

Sole TP 112 - D

● OPCIE / OPCIE / OPCIE / OPCÍOK :

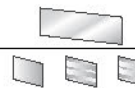

nanosan

Sole TP 112 - L, D

140

112-113



Dvodelni krilni zaslon za kopalno kad Beatrice na obračalnem zidnem profilu.

Prvo krilo na tečajih, preklopno na zunanjo stran, obe krili zložljivi na notranjo ali zunanjo stran.

Dvodijelni krilni paravan za kupaonsku kado Beatrice na zidnom profilu na okretanje.

Prvo krilo je na šarkama koje se preklapaju na vanjsku stranu. Oba krila se mogu sklopiti na unutrašnju ili vanjsku stranu.

Dvodelni tuš paravan za kado Beatrice na zidnom profilu koji se okreće.

Prvo krilo je na šarkama, drugo se preklapa na spoljašnju, a oba su sklopiva na unutrašnju ili spoljašnju stranu.

Kétszemes kádparaván a Beatrice sarok fürdőkádakhoz forgatható falprofilal.

A paraván sarokkádakra szerelhető. Az első szárny zsanérokron elfordítható a külső oldalra, Mindkét szárny összecukható a belső vagy a külső oldalra.

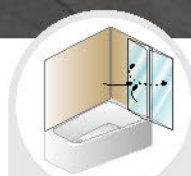

Beatrice



- Opora stekla za TP (tp 75,102,104,112,123)
- Držač stakla za TP (tp 75,102,104,112,123)
- Potpora stakla za TP (tp 75,102,104,112,123)
- Üvegfall támasz TP (tp 75,102,104,112,123)

■ OPCJE / OPCJE / OPCJE / OPCÍOK :



Specialno čistilo
Specijalno sredstvo za čišćenje
Specijalno sredstvo za čišćenje
Speciális tisztítószer

› 307

Vodni kamen je stvar preteklosti!

Vodeni kamenac stvar je prošlosti!
Vodeni kamenac je stvar prošlosti!
A vízkő a múlté!



Sole TP 112 Beatrice - L



Sole TP 112 Beatrice - D



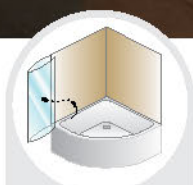

Allegro,
Royal,
Divante.



› 140-225 › 112-118 › 297 › 289-295 › 301 › 148

Dvodelni krilni zaslon TP 102 za kotno kopalno kad na obračalnem zidnem profilu.

Prvo krilo na tečajih, preklopno na zunanjo stran, obe krili zložljivi na notranjo ali zunanjo stran.

Dvodijelni krilni paravan TP 102 za kupaonsku kadu na zidnem profilu na okretanje.

Prvo krilo je na šarkama koje se preklapaju na vanjsku stranu. Oba krila se mogu sklopiti na unutrašnju ili vanjsku stranu.

Dvodelni tuš paravan TP 102 za ugaonu kadu na zidnom profilu koji se okreće.

Prvo krilo je na šarkama, drugo se preklapa na spoljašnju, a oba su sklopiva na unutrašnju ili spoljašnju stranu.

Kétrészes kádparaván TP 102 sarok fürdőkádakhoz forgatható falprofilal.

A paraván sarokkádakra szerelhető. Az első szárny zsanérokon elfordítható a külső oldalra, Mindkét szárny össze-csukható a belső vagy a külső oldalra.



- Opora stekla za TP (tp 75,102,104,112,123)
- Držać stakla za TP (tp 75,102,104,112,123)
- Potpora stakla za TP (tp 75,102,104,112,123)
- Üvegfal támasz TP (tp 75,102,104,112,123)

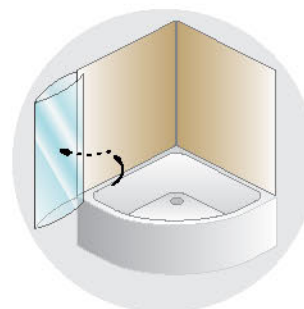

Sole TP 102 - L

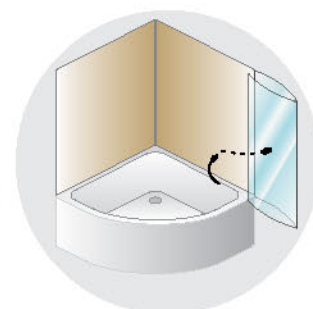

Sole TP 102 - D

• OPCJE / OPCUE / OPCJIE / OPCÍÓK :



Sole TP 102 - L, D

140

102

nanosan

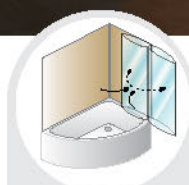

Chad.



› 140-225 › 112-118 › 297 › 289-295 › 301 › 148

Dvodielni krilni zaslon TP 102 za kopalno kad Chad na obračalnem zidnem profilu.

Prvo krilo na tečajjih, preklopno na zunanjo stran, obe krili zložljivi na notranjo ali zunanjo stran.

Dvodieljni krilni paravan TP 102 za kupaonsku kadu Chad na zidnom profilu na okretanje.

Prvo krilo je na šarkama koje se preklapaju na vanjsku stranu. Oba krila se mogu sklopiti na unutrašnju ili vanjsku stranu.

Dvodielni tuš paravan TP 102 za kadu Chad na zidnom profilu koji se okreće.

Prvo krilo je na šarkama, drugo se preklapa na spoljašnju, a oba su sklopiva na unutrašnju ili spoljašnju stranu.

Kétrészes kádparaván TP 102 fürdőkádakhoz Chad forgatható falprofilal.

A paraván sarokkádakra szerelhető. Az első szárny zsanérokon elfordítható a külső oldalra, Mindkét szárny össze-csukható a belső vagy a külső oldalra.



- Opora stekla za TP (tp 75,102,104,112,123)
- Držać stakla za TP (tp 75,102,104,112,123)
- Potpora stakla za TP (tp 75102,104,112,123)
- Üvegfal támasz TP (tp 75,102,104,112,123)

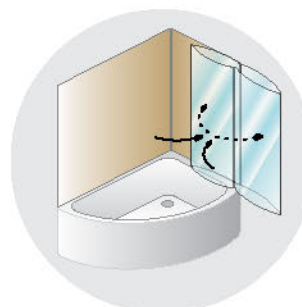

Sole TP 102 Chad - L



Sole TP 102 Chad - D

● OPCJE / OPCJIE / OPCJIE / OPCJÓK :



nanosan

Sole TP 102 Chad - L,D

140

102





Calando,
Lulu.

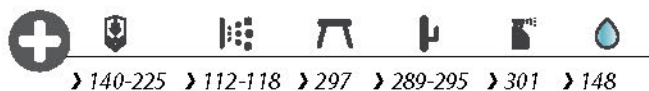

Dvodelni krilni zaslon TP 104 za kopalne kadi Calando in Lulu na obračalnem zidnem profilu.

Prvo krilo na tečajjih, preklopno na zunanjo stran, obe krili zložljivi na notranjo ali zunanjo stran.

Dvodijelni krilni paravan TP 104 za kupaonske kade Calando i Lulu na zidnom profilu na okretanje.

Prvo krilo je na šarkama koje se preklapaju na vanjsku stranu. Oba krila se mogu sklopiti na unutrašnju ili vanjsku stranu.

Dvodelni tuš paravan TP 104 za kade Calando i Lulu na zidnom profilu koji se okreće.

Prvo krilo je na šarkama, drugo se preklapa na spoljašnju, a oba su sklopiva na unutrašnju ili spoljašnju stranu.

Kétrészes kádparavan TP 104 fürdőkádkhoz Calando és Lulu forgatható falprofilal.

A paravan sarokkádkra szerelhető. Az első szárny zsanérokon elfordítható a külső oldalra, Mindkét szárny össze-csukható a belső vagy a külső oldalra.



- Opora stakla za TP (tp 75,102,104,112,123)
- Držać stakla za TP (tp 75,102,104,112,123)
- Potpora stakla za TP (tp 75102,104,112,123)
- Üvegfal támasz TP (tp 75,102,104,112,123)

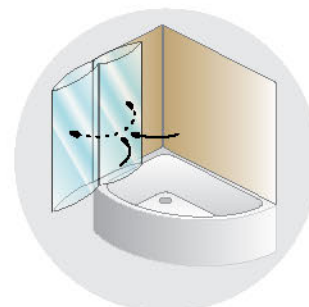
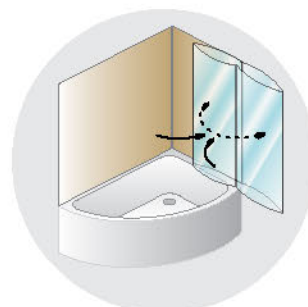

● OPCJE / OPCUE / OPCJIE / OPCÍOK :

Sole TP 104 - L

Sole TP 104 - D

Sole TP 104 - L, D



nanosan



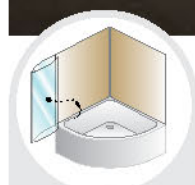

Largo,
Alba.



Dvodielni krilni zaslon TP 123 za kotno kopalno kad na obračalnem zidnem profilu.

Prvo krilo na tečajjih, preklopno na zunanjo stran, obe krili zložljivi na notranjo ali zunanjo stran.

Dvodieljni krilni paravan TP 123 za kupaonsku kadu na zidnom profilu na okretanje.

Prvo krilo je na šarkama koje se preklapaju na vanjsku stranu. Oba krila se mogu sklopiti na unutaranju ili vanjsku stranu.

Dvodielni tuš paravan TP 123 za ugaonu kadu na zidnom profilu koji se okreće.

Prvo krilo je na šarkama, drugo se preklapa na spoljašnju, a oba su sklopiva na unutrašnju ili spoljašnju stranu.

Kétrészes kádparaván TP 123 sarok fürdőkádakhoz forgatható falprofilal.

A paraván sarokkádakra szerelhető. Az első szárny zsanérokon elfordítható a külső oldalra, Mindkét szárny össze-csukható a belső vagy a külső oldalra.



- Opora stekla za TP (tp 75,102,104,112,123)
- Držač stakla za TP (tp 75,102,104,112,123)
- Potpora stakla za TP (tp 75,102,104,112,123)
- Üvegfal támasz TP (tp 75,102,104,112,123)

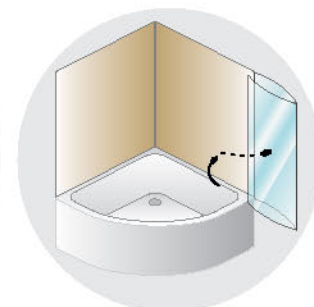
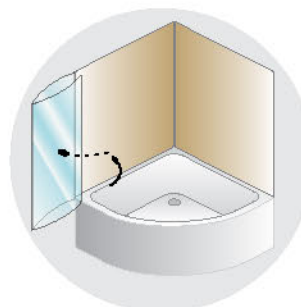

● OPCIJE / OPCJE / OPCJE / OPCÍOK :

Sole TP 123 - L

Sole TP 123 - D

Sole TP 123 - L, D



nanosan

140

123



Dvodelni krilni zaslon za kotno kopalno kad Loco na obračalnem zidnem profilu.

Prvo krilo na tečajih, preklopno na zunanjo stran, obe krili zložljivi na notranjo ali zunanjo stran.

Dvodijelni krilni paravan za kupaonsku kadu Loco na zidnem profilu na okretanje.

Prvo krilo je na šarkama koje se preklapaju na vanjsku stranu. Oba krila se mogu sklopiti na unutarnju ili vanjsku stranu.

Dvodelni tuš paravan za ugaonu kadu Loco na zidnom profilu koji se okreće.

Prvo krilo je na šarkama, drugo se preklapa na spoljašnju, a oba su sklopiva na unutrašnju ili spoljašnju stranu.

Kétszemes kádparaván a Loco sarok fürdőkádakhoz forgatható falprofilal.

A paraván sarokkádakra szerelhető. Az első szárny zsanérokön elfordítható a külső oldalra, Mindkét szárny összecsukszható a belső vagy a külső oldalra.

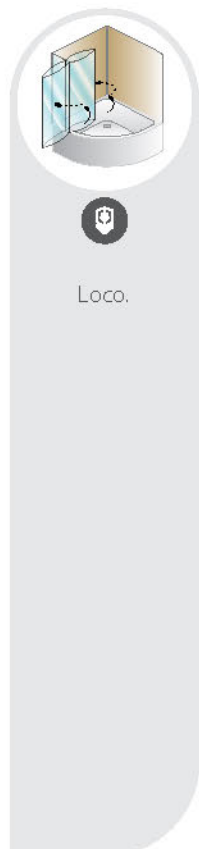
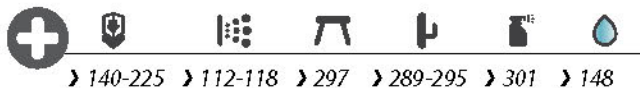

Specialno čistilo
Specijalno sredstvo za čišćenje
Specijalno sredstvo za čišćenje
Speciális tisztítószer

> 301

Vodni kamen je stvar preteklosti!
Vodeni kamenac stvar je prošlosti!
Vodeni kamenac je stvar prošlosti!
A vízkő a múlté!

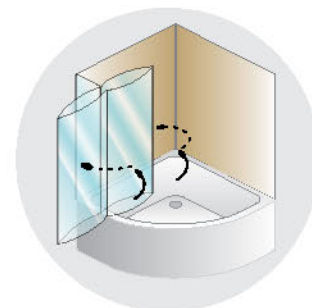

Sole TP 143 Loco - L



Sole TP 143 Loco - D



Sole TP 143 Loco - L, D

Dvodelni krilni zaslon za kopalno kad Fidelio na obračalnem zidnem profilu.

Prvo krilo na tečajjih, preklopno na zunanjo stran, obe krili zložljivi na notranjo ali zunanjo stran.

Dvodijelni krilni paravan za kupaonsku kadu Fidelio na zidnom profilu na okretanje.

Prvo krilo je na šarkama koje se preklapaju na vanjsku stranu. Oba krila se mogu sklopiti na unutrašnju ili vanjsku stranu.

Dvodelni tuš paravan za kadu Fidelio na zidnom profilu koji se okreće.

Prvo krilo je na šarkama, drugo se preklapa na spoljašnju, a oba su sklopiva na unutrašnju ili spoljašnju stranu.

Kétszemes kádparaván a Fidelio sarok fürdőkádhoz forgatható falprofilal.

A paraván sarokkádakra szerelhető. Az első szárny zsanérokön elfordítható a külső oldalra. Mindkét szárny összecsukszható a belső vagy a külső oldalra.



Fidelio.



› 140-225 › 112-118 › 297 › 289-295 › 301 › 148

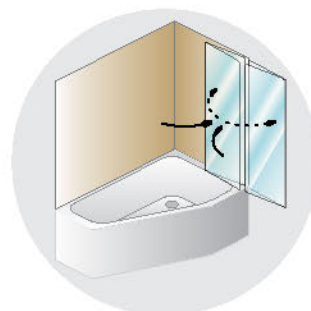

Sole TP Fidelio - L



Sole TP Fidelio - D



nanosan

Sole TP 90 Fidelio - L, D

140

90





Arabela.



› 140-225 › 112-118 › 297 › 289-295 › 301 › 148

Enodelni krilni zaslon za kopalno kad
Arabela 170 na obračalnem zidnem profilu.

Jednodijelni zaslon za kupaoničku kadu Arabela
170 na rotirajućem zidnom profilu.

Jednodelni krilni paravan za kadu za kupanje
Arabela 170 na zidnom profilu koji se može okretati.

Egyrészes szárnyellenző forgó fali profilon
Arabela 170 fürdőkádhoz.



Sole TP 80 Arabela - L



Sole TP 80 Arabela - D



nanosan

Sole TP 80 Arabela - L, D



155

80



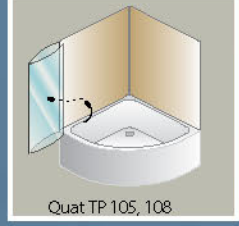
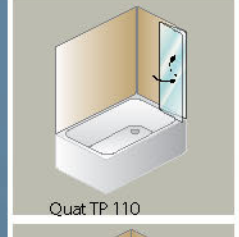
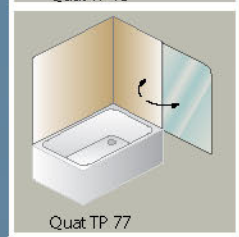
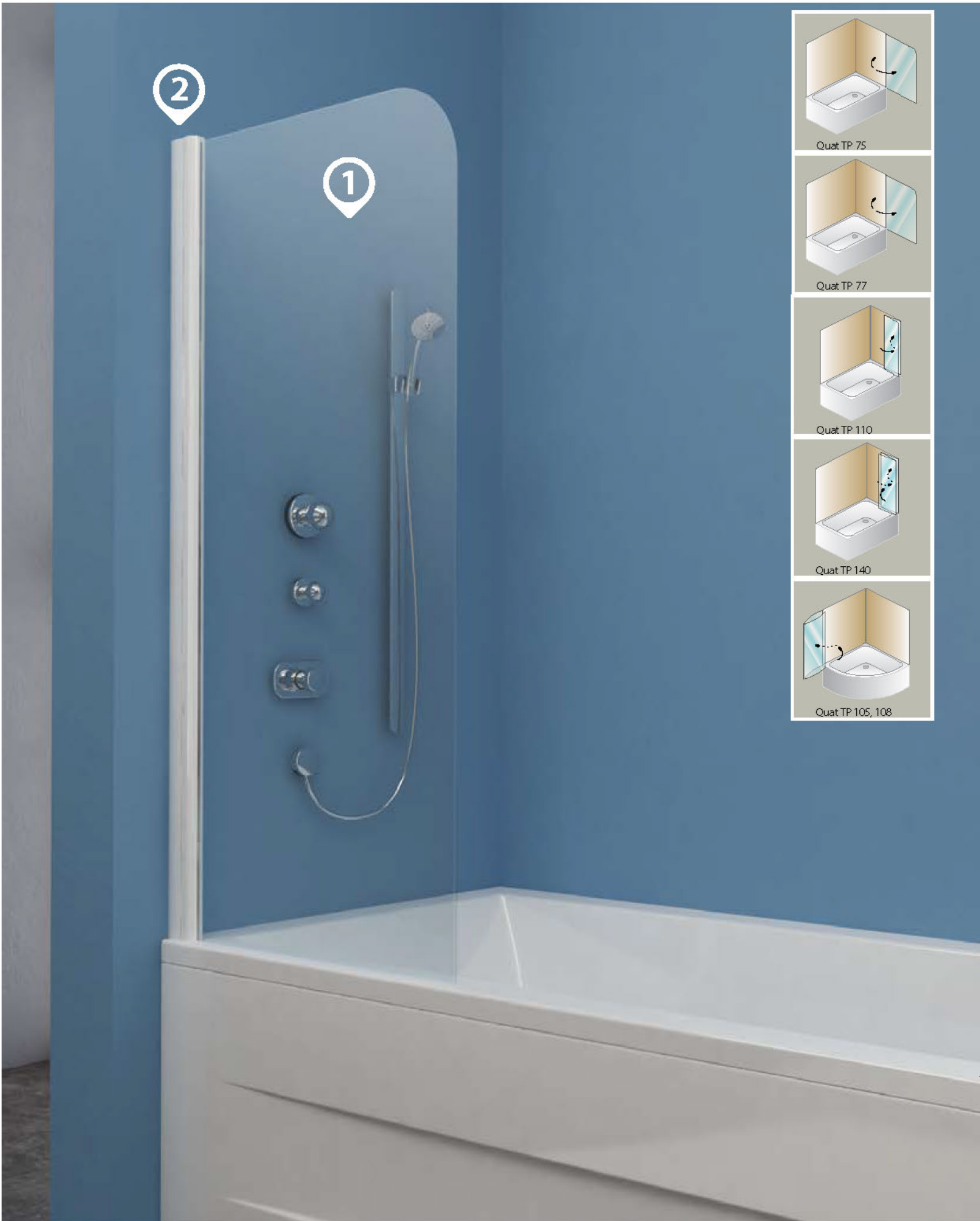

QUAT

Quat























5 mm prozorno kaljeno steklo
 5 mm kaljeno prozirno staklo
 5 mm prozirno kaljeno staklo
 5 mm átlátszó edzett üveg

1

2 mm polistirensko steklo Quat
 2 mm polistiren staklo Quat
 2 mm polistirensko staklo Quat
 2 mm Quat polisztiren üveg

2

Beli profili (prašno lakiranje)
 Bijeli profili (plastificiranje)
 Beli profili (lakiranje raspršivanjem)
 Fehér proflok (porlakkozás)

Quat								nanosan
Quat TP 75 - L, - D				140		75		
Quat TP 110				140		110		
Quat TP 140				140		135		
Quat TP 105				140		105		
Quat TP 108				140		108		

Bela
 Bijela
 Bela
 Fehér

Polistirensko steklo quat
 Polistirensko staklo quat
 Polistirensko staklo quat
 Polystyrol quat üveg

Kaljeno prozorno steklo
 Kaljeno prozirno staklo
 Kaljeno prozirno staklo
 Edzett átlátszó üveg

Vgradna mera
 Ugradbena mjera
 Ugradna mera
 Beépítési méretek



› 140-225 › 112-118 › 297 › 289-295 › 301 › 148

Enodelni krilni zaslon za kopalne kadi.

Mogućnost montaže
levo ali desno.

Jednodijelni krilni paravan za kupaonske kade.

Mogućnost montaže
lijevo ili desno.

Jednodielni tuš paravan za kadu.

Mogućnost montaže
levo ili desno.

Egyrészes paraván fürdőkádakhoz.

Bal- vagy jobb
beépítési lehetőség



Quat TP 75 - L

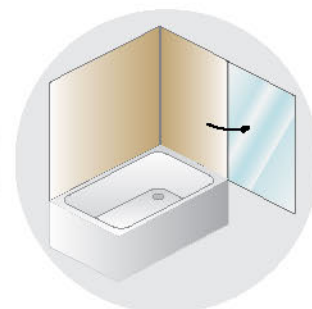

Quat TP 75 - D



73 - 75



140



Quat TP 75 - L, D



› 140-225 › 112-118 › 297 › 289-295 › 301 › 148

Zložljiv dvodelni krilni zaslon za kopalne kadi.
Možnost montaže levo ali desno.

Sklopivi dvodijelni krilni paravan za kupaonske kade.
Mogućnost montaže lijevo ili desno.

Sklopivi dvodelni tuš paravan za kadu.
Mogućnost montaže levo ili desno.

Összecsukható kétrészes paravan fürdőkádakhoz.
Bal- vagy jobb beépítési lehetőség.



Quat TP 110

140

110



› 140-225 › 112-118 › 297 › 289-295 › 301 › 148

Zložljiv trodelni krilni zaslon za kopalne kadi.

Možnost montaže
levo ali desno.

Sklopivi dvodijelni krilni paravan za kupaonske kade.

Mogućnost montaže
lijevo ili desno.

Sklopivi trodelni tuš paravan za kadu.

Mogućnost montaže
levo ili desno.

Összecsukható háromrészes paravan fürdőkádakhoz.

Bal- vagy jobb beépítési lehetőség.



Quat TP 140



140

135



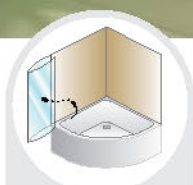

Quat TP 105: Alba,
Largo, Allegro,
Royal, Divante.

Quat TP 108: Lulu,
Calando.



› 140-225 › 112-118 › 297 › 289-295 › 301 › 148

**Zložljiv dvodelni krilni zaslon
za kotne kopalne kade.**

Možnost montaže levo ali desno.

**Sklopivi dvodijelni krilni paravan za
kutne kupaonske kade.**

Mogućnost montaže lijevo ili desno.

**Sklopivi dvodelni tuš
paravan za ugaone kade.**

Mogućnost montaže levo ili desno.

**Összeraktható kétrészes szárnyas ellenző
sarkos fürdőkádakhoz.**

Bal, illetve jobboldali szerelés lehetősége.

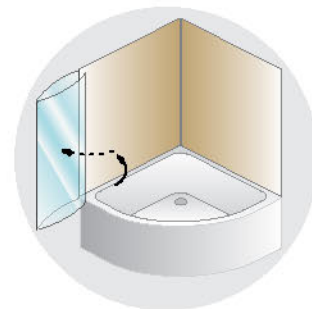

Quat TP 105



140

105



Quat TP 108



140

108

