



KOPALNE IN MASAŽNE KADI

BATHTUBS



02

Massage and bathtubs
 Massage- und Badewannen
 Массажные Ванны И Ванны
 Masszázs- és fürdőkádkak

Bathtub intimacy

The Kolpasan bathtub helps us create our own sanctuary in the bathroom for pampering and relaxation. Warm water reduces stress, heightens senses, relaxes us and generally affects our well being. It becomes our personal space in which to escape from the outside world as well as unleash and restore our internal balance.

Intimität der Badewanne

Mit der Badewanne Kolpasan schaffen wir unseren eigenen Tempel für Verwöhnung und Entspannung im Badezimmer. Warmes Wasser baut Stress ab, weckt Gefühle, entspannt uns und wirkt allgemein auf unser Wohlbefinden. Darin schaffen wir unseren persönlichen Raum, in dem wir uns von der Außenwelt entfernen, entspannen und unser inneres Gleichgewicht wieder herstellen.

Уединенность ванны

Ванна Kolpasan помогает нам создать в нашей ванной комнате святую святых для ухода за телом и расслабления. Теплая вода снимает стресс, пробуждает чувства, расслабляет нас и в целом способствует тому, чтобы мы чувствовали себя лучше. В ней мы создаем для себя личное пространство, в котором удаляемся от внешнего мира, расслабляемся и восстанавливаем внутренний баланс.

A fürdőkád intimitása

A Kolpasan fürdőkáddal a fürdőszobában megteremtjük a kényeztetésre, kikapcsolódásra szolgáló szentélyünket. A meleg víz csökkenti a stresszt, felébreszti az érzékeket, ellazít minket, és javítja közérzetünket. Ez az a hely, ahol megteremtjük személyes terünket, ahol eltávolodunk a külvilágtól, ellazulunk és helyreállítjuk belső egyensúlyunkat.



10
years warranty
Jahre Garantie

*

2
years warranty
Jahre Garantie

**



* cast sanitary acrylic, gegossenes Sanitäracryl, литой санитарный акрил, öntött szaniterakril
kerrock, Kerrock, кеппок, kerrock

** massage systems, Massagesysteme, массажная система, masszázrendszer



02

022

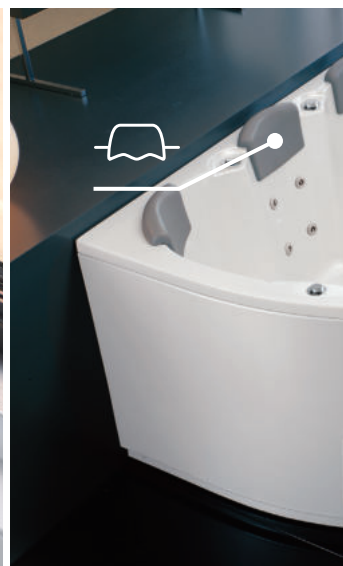



BATHTUBS BADEWANNEN ВАННЫ FÜRDŐKÁDAK



- a choice of **4** massage systems
- Auswahl von **4** Massagesystemen
- возможность выбора между **4** массажными системами
- **4** masszázrendszer közül választhat



- a choice of different quality materials (Kerrock and sanitary cast acrylic)
- Auswahl zwischen verschiedenen Qualitäten von Materialien (Kerrock und Sanitär-Gussacryl)
- возможность выбора между различными качественными материалами (керрок и литой санитарный акрил)
- különböző minőségi anyagok között választhat (Kerrock és öntött szaniter akril)



- ergonomic form with pure geometric lines
- Ergonomische Form mit reinen geometrischen Linien
- эргономический дизайн с чистыми геометрическими формами
- ergonomikus kialakítás geometriás alakzatokkal



- a large variety of bathtub accessories available (massage systems, faucets, seats and headrests)
- Möglichkeit eines Überbaus der Wanne mit Überstandardelementen (Massagesysteme, Armaturen, Sitze und Kopfstützen)
- возможность модернизации ванны с выше-стандартными элементами (массажные системы, сантехническая арматура, сиденья, подголовники)
- a kád felszerelésének a lehetősége több kiegészítő elemmel (masszázrendszerek, csaptelepek, fejpárnák, ülőkék)



- a selection of different screens and enclosures
- Möglichkeit eines Überbaus mit Duschtrennwänden und Kabinen
- возможность модернизации с душами параванами и кабинами
- felszerelés lehetősége kádpáravánokkal



- various options for installation (standalone, built-in with tub surround wall or panel)
- Möglichkeiten des Auf- und Einbaus (selbstsehende, Montage mit gemauertem Rand oder Mit Belägen)
- различные варианты компоновки и установки (отдельные, встраиваемые)
- különböző beállítási és beépítési lehetőségek (önálló, beépített épített szegéllyel, vagy burkolattal)

80

- more than **80** models of bath tubs for a variety of bathroom layouts
- mehr als **80** Modelle von Badewannen für die Ausstattung von verschiedenen Arten von Badezimmern
- более **80** моделей ванн для оборудования всех видов ванных комнат
- több mint **80** fürdőkád modell



- possibility of adjusting the shape of certain models
- bei bestimmten Modellen kann die Form angepasst werden
- возможность корректировки формы некоторых моделей
- egyes modellek alakja az igényekhez igazítható



- chromotherapy
- Chromotherapie
- хромотерапия
- fényterápia



Bathtubs - shapes and sizes

Badewannen - Formen und Grössen

Ванны – таблица форм и размеров

Fürdőkádak – áttekintés formák és dimenziók szerint

a x b	68	70	75			78	80					85			
200														Atys 046	
197															
195															
190															
185													Elektra SP 058	Elektra SP LD 065	
180								Gloria-FS 040 Ramona-FS 042 Soft-FS 051	Dream SP 059	Betty 070 Betty E2 071 Copelia-FS 037 Copelia-LIGHT 039 Elektra 074 Soft 052 Tamia 078	Dream SP LD 066	Atys FS 044 Blanche-FS 041		Atys/O 045 Pandora 076	
175				Elektra SP 058		Elektra SP LD 065									
174		Atys DUO-FS 043			Milo-FS 047										
173						Pandora FS 054									
170			Betty 070 Betty E2 071 Elektra 074 Evelin 077 Tamia 078	Dream SP 059	Betty 070 Betty E2 071 Elektra 074 Evelin 077 Figaro 080 Pandora 076 Tamia 078	Dream SP LD 066		Dalia-FS*** 055		Betty 070 Betty E2 071 Elektra 074		Lux-FS 056		Lux 057	
165												Boul-FS 048			
163	Pandora FS 054														
160			Betty 070 Evelin 077 Tamia 078		Elektra 074					Figaro 080					
150			Betty 070 Evelin 077 Figaro 080 Tamia 070											Calando 069	
140			Betty 070 Evelin 077 Tamia 078 Tamia/S** 079												
130			Betty 070												
120			Betty 070												
100			Mini* 081												

Info

a x b dimensions in cm:
Abmessungen in cm:
размеры в см:
dimenziók cm-ben:

- shape: / Form: / форма: / forma:
- oval, Oval, овальная, ovális
- round, Runde, круглая, kerek
- along the wall, Entlang der Wand, вдоль стены, a fal mentén
- corner, Ecke, угловая, sarkos
- classical, Klassisch, классическая, hagyományos
- asymmetrical, Asymmetrisch, асимметричная, asszimmetrikus

000 page:
Seite:
страница:
oldalszám:



Select the size of your bathtub and check next page to see where in the catalogue you can find it.

Suchen Sie die richtigen Abmessungen für Ihre Badewanne aus. Dann schauen Sie auf der nächsten Seite, wo im Katalog es finden können.
 Выберите себе ванну желаемого размера. На следующей странице каталога указана страница, где ее можно посмотреть.
 Keresse meg a megfelelő nagyságú kádat, a következő oldalon pedig keresse meg, hol található a katalógusban.



a x b	90	100	110	117	120	125	130	140	150	160	180
200	Betty 070	Atys 046									
197				Tristan* 036							
195						Adam&Eva 072					
190	Betty 070 Elektra 074				Adam&Eva FS 049 Nabucco 073						
185	Comodo-FS 050										
180	Marilyn-FS 053	Copala-LUX-FS 038								Samson 075	Opera 060
175											
174											
173											
170				Beatrice 068 Libretto 067							
165											
163											
160		Calando 069		Libretto 067						Gaia 061	
150									Dolores** 062		
140								Dolores** 062 Divante** 063			
130							Dolores** 062 Royal** 064				
120					Royal** 064						
100											

Info

* bathtub without cladding
 * Badewanne ohne Schürze
 * ванна без обшивки
 * kád burkolat nélkül

** bathtub with an installed seat
 ** Badewanne mit integriertem Sitz
 ** ванна со встроенным сиденьем
 ** kád beépített ülésel

*** bathtub and cladding in one unit
 *** Badewanne und Schürze in einem Stück
 *** ванна с обшивкой
 *** kád és kádburkolat egyben

Massage and bathtubs
 Massage- und Badewannen
 Массажные ванны и ванны
 Massázs- és fürdőkádkak

026



TRISTAN-FS 197x117 036

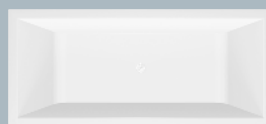

COPELIA-FS 180x80 037



COPELIA LUX-FS 180x100 038



COPELIA LIGHT-FS 180x80 039



GLORIA-FS 180x80 040



BLANCHE-FS 180x85 041

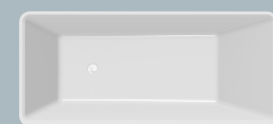

RAMONA bathtub-FS 180x80 042



ATYS DUO-FS 174x70 043



ATYS-FS 180x85 044



ATYS/O 180x85 045



ATYS 200x100 046



MILO bathtub-FS 174x75 047



BOUL bathtub-FS 165x85 048



ADAM & EVA-FS 190x120 049



COMODO-FS 185x90 050



new
SOFT-FS 180x80 051



new
SOFT-FS 180x80 052

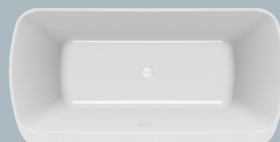

MARILYN-FS 180x90 053



PANDORA bathtub-FS 173x78, 163x68 054



DALIA-FS 170x80 055



new
LUX-FS 170x85 056



new
LUX 170x85 057



new
ELEKTRA-SP 185x85, 175x75 058



DREAM-SP 180x80, 170x75 059



OPERA Ø 180 060

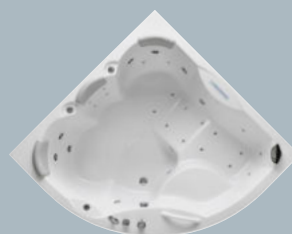

GAIA 160x160 061



new
DOLORES 150x150, 140x140, 130x130 062

Info



DIVANTE 140x140 063



ROYAL 130x130, 120x120 064

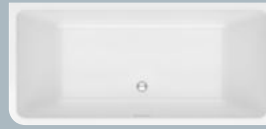

new
ELEKTRA-SP -L 185x85, 175x75 065

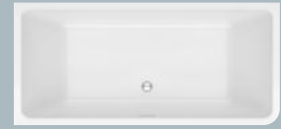

new
ELEKTRA-SP -R 185x85, 175x75 065



new
DREAM-SP -L 180x80, 170x75 066



new
DREAM-SP -R 180x80, 170x75 066



new
LIBRETTO -L 170x110, 160x100 067



new
LIBRETTO -R 170x110, 160x100 067

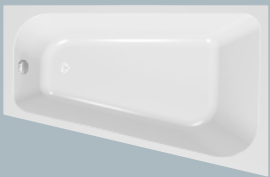

BEATRICE-L 170x110(70) 068



BEATRICE-R 170x110(70) 068



CALANDO-L 160x90, 150x85 069

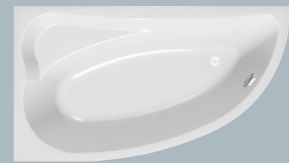

CALANDO-R 160x90, 150x85 069



new
BETTY 200x90, 190x90 070



new
BETTY 180x80, 170x80, 170x75, 170x70, 160x70, 150x70, 140x70, 130x70, 120x70 070



new
BETTY E2 180x80, 170x80, 170x75, 170x70 071



ADAM & EVA 195x125 072



NABUCCO 190x120 073



ELEKTRA 190x90, 180x80, 170x80, 170x75, 170x70, 160x75 074



SAMSON 180x160 075



PANDORA bathtub 180x85, 170x75 076

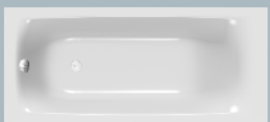

EVELIN bathtub 170x75, 170x70, 160x70, 150x70, 140x70 077



TAMIA 180x80, 170x75, 170x70, 160x70, 150x70, 140x70 078



TAMIA 140x70/S 079

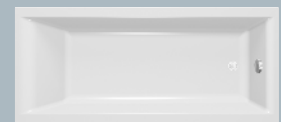

FIGARO 170x75, 160x80, 150x70 080



MINI 100x70 081



Option of installation and upgrade of bathtubs

Möglichkeiten der Montage und des Ausbaus von Badewannen

Возможности установки и модернизации ванн

Fürdőkádak beépítésének és átépítésének lehetősége.



Massage bathtubs

Massagebadewannen

Массажные системы в ваннах

Fürdőkád masszázrendszerék



Water massage system

Wassermassagesystem

Система гидромассажа

Vízmasszázs rendszerek

> 32



Air massage system

Luftmassagesystem

Система аэромассажа

Levegőmasszázs rendszer

> 34



Water and air massage system

Wasser- und Luftmassagesystem

Системы аэро - и гидромассажа

Víz - és levegőmasszázs rendszerek

> 33



Vital massage system

Vital Massage Systeme

Массажная система Vital

Vital masszázrendszer

> 35



Super water jet

Super Wasserdüse

Супер водяная форсунка

Szuper vízfúvóka

Ø cca 70 mm, angle 30 ° in all directions

Ø cca 70 mm, Winkel 30 ° in alle Richtungen

Ø cca 70 mm, угол 30 ° во всех направлениях

Ø cca 70 mm, szög 30 ° minden irányban



Water jet

Wasserdüse

Водяная форсунка

Vodena mlaznica

Ø cca 64 mm, angle 15 ° in all directions

Ø cca 64 mm, Winkel 15 ° in alle Richtungen

Ø cca 64 mm, угол 15 ° во всех направлениях

Ø cca 64 mm, szög 15 ° minden irányban



Micro water jet

Wassermikrodüsen

Микро водяная форсунка

Mikró vízfúvóka

Ø cca 28 mm

Ø ca. 28 mm

Диаметр около 28 мм

Ø cca 28 mm



Air jet

Luftdüsen

Воздушная форсунка

Levegőfúvóka

Ø cca 27 mm

Ø ca. 27 mm

Диаметр около 27 мм

Ø cca 27 mm



6 micro water jets (for back massage)

6 Mikro-Wasserdüsen (für Rückenmassage)

6 водяных микро форсунок (для массажа спины)

6 mikró vízfúvóka (hátmassázshoz)

Ø cca 28 mm

Ø ca. 28 mm

Диаметр около 28 мм

Ø cca 28 mm

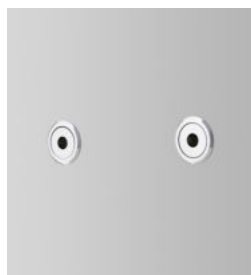

2 micro water jets (for foot massage)

2 Mikro-Wasserdüsen (für Fußmassage)

2 водяные микро форсунки (для массажа ступней)

2 mikró vízfúvóka (talpmassázshoz)

Ø cca 28 mm

Ø ca. 28 mm

Диаметр около 28 мм

Ø cca 28 mm



i **Installation**
Montage
Установка
Beépítés

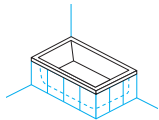

Bathtub, built-in

Badewanne, zum Einbau
Встраиваемая ванна
Beépíthető fürdőkád.

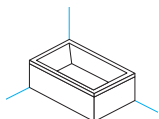

Bathtub with panel

Badewanne mit Schürze
Ванна с панелью
Fürdőkád előlappal.

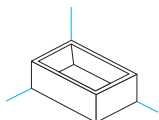

Bathtub with fixed panel

Badewanne mit geklebter Beschichtung
Ванна с ламинированным покрытием
Fürdőkád ragasztott burkolattal

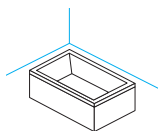

Freestanding bathtub with panel

Freistehende Badewanne mit Schürze
Отдельная ванна с покрытием
Önálló fürdőkád burkolattal

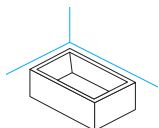

Freestanding bath tub with fixed panel

Freistehende Badewanne
mit geklebter Schürze
Отдельная ванна
с ламинированным покрытием
Önálló fürdőkád ragasztott burkolattal

+ **Upgrade**
Ausbau
Модернизация
Felszereltség

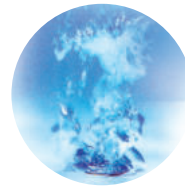

Massage system

Massagesystem
Массажная система
Masszázsrendszer

> 28

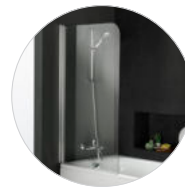

Shower screens

Duschtrennwände
Душ параван
Paravánszárnyak - Zuhanyparavánok

> 216



Accessories

Zubehör
Аксессуары для ванн
A fürdőkádak kiegészítői

> 320



Headrests

Kopfstützen
Подголовники
Fejtámaszok

> 331



Bathroom seats

Badsitze
Сиденья для ванных комнат
Fürdőszobai ülések

> 332

030



Massage bathtubs
 Massagebadewannen
 Массажные системы в ваннах
 Fürdőkád masszázrendszer

Water massage system I. PNEUMATIC	Water and air massage system ELECTRONIC	Air massage system ELECTRONIC	Vital massage system ELECTRONIC	Micro water jets for massage systems OPTIONS (Massage for the back)
Wassermassage System I. PNEUMATISCH	Wasser- und Luftmassagesystem ELEKTRONISCH	Luftmassagesystem ELEKTRONISCH	Vital Massagesystem ELEKTRONISCH	Mikro-Wasserdüsen für Massagesysteme OPTIONEN (Massage für den Rücken)
Система гидромассажа I. ПНЕВМАТИЧЕСКАЯ	Система аэро- и гидромассажа ЭЛЕКТРОННАЯ	Система аэромассажа ЭЛЕКТРОННАЯ	Система массажа Витал ЭЛЕКТРОННАЯ	Водяные микро форсунки для массажных систем Опции (массаж для спины)
Vizmasszázs rendszer I. PNEUMATIKUS	Víz-és levegőmasszázs rendszer ELEKTRONIKAI	Levegőmasszázs rendszer ELEKTRONIKAI	Vital masszázrendszer ELEKTRONIKAI	Mikro vízfúvókák masszázrendszeréhez LEHETŐSÉGEK (Hátmasszázsához)

INFO





Copelia Light-FS 180			•		
Adam&Eva-FS 190			•		
Comodo-FS 185			•		
Marilyn-FS 180			•		
Dream-SP 180, 170			•		
Opera 180/O				•	
Gaia 160				•	
Gaia 160/O				•	
Dolores 150/O, 140/O	•	•		•	•
Divante 140/O	•				
Royal 130/O	•	•			
Dream-SP -L, -R 180, 170			•		
Libretto 170/O, 160/O	•	•		•	•
Beatrice 170/O	•	•		•	•



Massage bathtubs
 Massagebadewannen
 Массажные системы в ваннах
 Fürdőkádk masszázrendszerék



Water massage system I. PNEUMATIC	Water and air massage system ELECTRONIC	Air massage system ELECTRONIC	Vital massage system ELECTRONIC	Micro water jets for massage systems OPTIONS (Massage for the back)
Wassermassage System I. PNEUMATISCH	Wasser- und Luftmassagesystem ELEKTRONISCH	Luftmassagesystem ELEKTRONISCH	Vital Massagesystem ELEKTRONISCH	Mikro-Wasserdüsen für Massagesysteme OPTIONEN (Massage für den Rücken)
Система гидромассажа I. ПНЕВМАТИЧЕСКАЯ	Система аэро- и гидромассажа ЭЛЕКТРОННАЯ	Система аэромассажа ЭЛЕКТРОННАЯ	Система массажа Витал ЭЛЕКТРОННАЯ	Водяные микро форсунки для массажных систем ОПЦИИ (массаж для спины)
Vízmasszázs rendszer I. PNEUMATIKUS	Víz-és levegőmasszázs rendszer ELEKTRONIKAI	Levegőmasszázs rendszer ELEKTRONIKAI	Vital masszázrendszer ELEKTRONIKAI	Mikro vízfúvókák masszázrendszeréhez LEHETŐSÉGEK (Hátmasszázsához)

 	Calando 160/O, 150/O	•	•		
	Betty 200/O, 190/O, 180/O, 170x80/O, 170x75/O, 170x70/O	•	•	•	•
	Betty 160/O	•	•		•
	Adam&Eva 195/O	•	•	•	•
	Nabucco 190/O	•	•	•	•
	Elektra 190/O, 180/O, 170x80/O, 170x75/O, 160/O	•	•	•	•
	Samson 180		•	•	
	Samson 180/2O, Samson 180/4O		•	•	
	Pandora bathtub 180/O, 170/O	•	•		•
	Evelin bathtub 170x75/O	•			
	Tamia 180/O, 170x75/O	•			



Water massage system (pneumatic)
 Wassermassagesystem (pneumatisch)
 Система гидромассажа (пневматическая)
 Vízmasszázs rendszerek (pneumatikus)

This hydro massage system is based on pressure created by water pump directing water flow through massage jets as mixture of water and air. As a result, your body is being intensively massaged by thousands of extremely rapidly moving air bubbles. A regulation system allows controlling air and water flow through the massage jets.

Das Hydromassagesystem basiert auf durch die Wasserpumpe erzeugtem Druck, welcher den Strahl aus Wasser und Luft durch die Massagedüsen leitet. Durch Tausende von schnellbewegenden Luftbläschen wird der ganze Körper intensiv massiert. Durch eine Luftflusssteuerung wird die Stärke des Massagestrahls geregelt.

Система гидромассажа работает таким образом: водяной насос создает давление и приток воды через массажные сопла, которые направляют струю воды смешанную с воздухом. Тысяча воздушных шариков с большой скоростью воды интенсивно массируют человека. Приток воды контролируется отмеренным поступлением воздуха в массажные форсунки.

A vízmasszázs rendszer működési elve: szivattyú továbbítja a vizet masszázsfúvókákon keresztül a fürdőkádba. Ezek irányítják a levegővel dúsított vizet. A légbuborékok ezrei a nagy sebességű vízzel intenzíven masszírozzák az emberi testet. A masszázsfúvókákon keresztül áramló levegőmennyiség szabályozásával beállítható a masszírozó sugár erőssége.

WATER

System functions:

- water pump
- water jets
- pneumatic switch
- air flow regulator min-max
- overflow set
- bathtub support frame
- bathtub panel
- high performance waterpump, 6 microjets with switch
- 2 additional water microjets

Systemfunktionen:

- Wasserpumpe
- Wasserdüsen
- Pneumatikschalter
- Luftdurchflussregler Min - Max
- Überlaufgarnitur
- Badewannenuntergestell
- Schürze
- Hochleistungswasserpumpe, 6 Mikrodüsen mit Schalter
- 2 zusätzliche Wassermikrodüsen

Состав системы:

- водяной насос
- водяных форсунок
- пневматическое включение
- регулятор потока воздуха мин-макс.
- слив-перелив
- основание ванны
- покрытие ванны
- 6 водяных микро-форсунок с переключателем и водяным насосом
- две дополнительные водяные микро-форсунки

Rendszerfunkciók:

- vízszivattyú
- vízfúvóka
- pneumatikus bekapcsolás
- min-max levegőáramlás szabályozó
- túlfolyó készlet
- fürdőkád lábazata
- fürdőkádburkolat
- 6 mikro-vízfúvóka kapcsolóval és vízszivattyúval
- kettő kiegészítő mikro-vízfúvóka



○ OPTIONS FOR CERTAIN BATHTUB MODELS:
 ○ OPTIONEN FÜR BESTIMMTE BADEWANNENMODELLE:
 ○ ВАРИАНТЫ ДЛЯ ОПРЕДЕЛЕННЫХ ТИПОВ ВАНН:
 ○ OPCÍÓK EGYES FÜRDŐKÁD MODELLEKHEZ:





Water and air massage system (electronic)

Wasser- und Luftmassagesystem (elektronisch)

Системы аэро - и гидромассажа (электронная)

Víz - és levegőmasszázs rendszerek (elektronikai)

033



This system combines both water and air massage systems. Their interacting effect does great work for human organism with pure relaxation and a complete regeneration as a result. The air massage system is based on the air pressure generated by an air pump. The strong flow of compressed air running through the air nozzles results in millions of tiny air bubbles mixing with water and moving at high speed. It is their kinetic energy which provides massage to your body.

In diesem System sind alle Elemente von Wasser- und Luftmassagesystem integriert. In einem Wechselspiel wirken beide Systeme intensiv auf den menschlichen Organismus wodurch er entspannt und regeneriert wird. Das Luftmassagesystem basiert auf durch die Luftpumpe erzeugtem Druck, welcher die komprimierte Luft durch Luftdüsen leitet. Diese Die entstandenen Luftbläschen, die sich mit dem Wasser vermischen und mit großer Geschwindigkeit bewegen, massieren mit ihrer kinetischen Energie den Körper.

В систему включены все элементы водяной и воздушной массажной системы. Взаимодействие этих двух систем интенсивно действует на человеческий организм, его полностью регенерирует и расслабляет. Воздушная массажная система работает следующим образом: водяной насос создаёт поток сжатого воздуха, который проходит через воздушные форсунки. Форсунки разбивают воздух на мелкие воздушные пузырьки, смешивающиеся с водой, своей кинетической энергией массируют тело пользователя.

A rendszer a víz és a levegő masszázrendszer minden elemét tartalmazza. A két rendszer kölcsönös, párhuzamos működése intenzíven hat az emberi testre, teljesen regenerálja és relaxálja. A levegőmasszázs rendszer úgy működik, hogy a levegőszivattyú nyomás alatti levegőt áramoltat a levegőfúvókákon keresztül. A fúvókák a levegőt apró levegőbuborékokba törik, ezek pedig vízzel keverednek. A buborékok kinetikus energiájuk folytán végzik a masszázst.

System functions:

- air pump
- water pump
- super water jets
- air jets
- electronic switch for water and air pumps
- air flow regulator min-max
- electronic regulation of the air pump rpm
- water level sensor
- overflow set
- bathtub support frame
- bathtub panel
- high performance water pump, 6 water microjets with switch
- 2 additional water microjets

Systemfunktionen:

- Luftpumpe
- Wasserpumpe
- Hochleistungswasserdüsen
- Lüftdüsen
- elektronische Einschaltung für die Wasser- und Luftpumpe
- Luftdurchflussregler Min - Max
- Elektroregelung für die Drehzahl der Luftpumpe
- Sensor für das Wasserniveau
- Abfluss - Durchflussgarnitur
- Untergestell
- Schürze
- Hochleistungswasserpumpe, 6 Mikrodüsen mit Schalter
- 2 zusätzliche Wassermikrodüsen

Состав системы:

- воздушный насос
- водяной насос
- супер водяные форсунки
- воздушных форсунок
- электронное включение водяного и воздушного насосов
- регулятор потока воздуха мин.-макс.
- электронная регулировка количества оборотов водяного насоса
- датчик уровня воды
- слив-перелив
- основание ванны
- покрытие ванны
- 6 водяных микро-форсунок с переключателем и водяным насосом
- 2 дополнительные водяные микро-форсунки

Rendszerfunkciók:

- levegőszivattyú
- vízszivattyú
- szuper vízfúvóka
- levegőfúvóka
- a víz- és a levegőszivattyú elektronikai bekapcsolása
- min-max levegőáramlás szabályozó
- a levegőszivattyú fordulatszámának elektronikai szabályozása
- vízszint érzékelő
- túlfolyó készlet
- fürdőkád lábazat
- fürdőkád burkolat
- 6 mikro-vízfúvóka kapcsolóval és erősebb vízszivattyúval
- 2 kiegészítő mikro-vízfúvóka

WATER & AIR



- OPTIONS FOR CERTAIN BATHTUB MODELS:
- OPTIONEN FÜR BESTIMMTE BADEWANNENMODELLE:
- ВАРИАНТЫ ДЛЯ ОПРЕДЕЛЕННЫХ ТИПОВ ВАНН:
- OPCÍOK EGYES FÜRDŐKÁD MODELLEKHEZ:





Air massage system (FS / SP bathtubs only)

Luftmassagesystem (nur für FS / SP Badewannen)

Система аэромассажа (только для ванн ФС/СП)

Levegőmasszázs rendszer (csak FS / SP kádakhoz)

034



AIR

System functions:

- air pump
- air jets
- electronic switch for air pump
- water level sensor
- overflow set
- bathtub support frame
- bathtub panel

Systemfunktionen:

- Luftpumpe
- Luftdüsen
- elektronische Einschaltung für die Luftpumpe
- Sensor für das Wasserniveau
- Abfluss - Durchflussgarnitur
- Untergestell
- Schürze

Состав системы:

- водяной насос
- воздушных форсунок
- электронное включение водяного насоса
- датчик уровня воды
- слив-перелив
- основание ванны
- покрытие ванны

Rendszerfunkciók:

- levegőszivattyú
- levegőfúvóka
- a levegőszivattyú elektronikai bekapcsolása
- vízszint érzékelő
- túlfolyó készlet
- fürdőkád lábazat
- fürdőkád burkolat

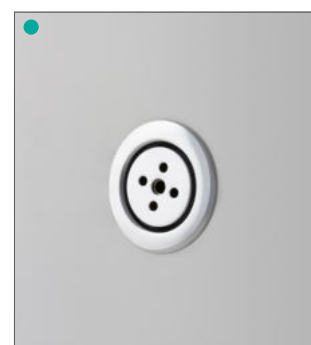



Water and air massage system (electronic)

Wasser- und Luftmassagesystem (elektronisch)

Системы аэро - и гидромассажа (электронная)

Víz - és levegőmasszázs rendszerek (elektronikai)

035



System functions:

- air pump
- water pump
- super water jets
- air jets
- 2 additional water microjets
- 6 water microjets with switch
- airflow regulator min-max
- electronic switch for water and air pump
- water level sensor
- chromotherapy light
- ozone
- interval regulation for water
- oscillating regulation for air
- heater for maintaining water temperature
- programming the desired water temperature
- overflow set
- bathtub support frame
- bathtub panel

Systemfunktionen:

- Luftpumpe
- Wasserpumpe
- Superwasserdüsen
- Luftdüsen
- 2 zusätzliche Wassermikrodüsen
- 6 Wassermikrodüsen mit Schaltung
- Luftfluss Regulator Min - Max
- elektronische Einschaltung für die Wasser und die Luftpumpe
- Sensor für das Wasserniveau
- Licht mit Chromotherapie
- Ozon
- Intervallregulierung für das Wasser
- Schwingregulierung für die Luft
- Heizkörper, um die Wassertemperatur zu halten
- Programmierung der gewünschten Wassertemperatur
- Ausfluss - Durchflussgarnitur
- Badewannenuntergestell
- Badewannen Schürze

- OPTIONS FOR CERTAIN BATHTUB MODELS:
- OPTIONEN FÜR BESTIMMTE BADEWANNENMODELLE:
- ВАРИАНТЫ ДЛЯ ОПРЕДЕЛЕННЫХ ТИПОВ ВАНН:
- OPCÍOK EGYES FÜRDŐKÁD MODELLEKHEZ:

Состав системы:

- воздушный насос
- водяной насос
- супер водяных форсунок
- воздушных форсунок
- 2 дополнительные водяные микро-форсунок
- 6 водяных микро-форсунок с переключателем
- регулятор потока воздуха мин.- макс.
- электронное включение водяного и воздушного насоса
- датчик уровня воды
- лампочки с хромотерапией
- озон
- интервальный регулятор для воды
- регулятор воздуха
- нагреватель для поддержания температуры воды
- программирование требуемой температуры воды
- слив-перелив
- основание ванны
- покрытие ванны

Rendszerfunkciók:

- vízszivattyú
- levegőszivattyú
- szuper vízfúvóka
- levegőfúvóka
- 2 kiegészítő mikro-vízfúvóka
- 6 átkapcsolható mikro-vízfúvóka
- min - max levegőáram szabályozó
- a levegő- és a vízszivattyú elektronikai bekapcsolása
- vízszint érzékelő
- kromoterápiás lámpa
- ózon
- levegő intervallumos szabályozása
- víz oszcilláló szabályozása
- vízhőmérséklet szinten tartására beépített melegítőtest
- a kívánt vízhőmérséklet programozása
- túlfolyó készlet
- fürdőkádlábazat
- fürdőkádkurkolat



Gaia

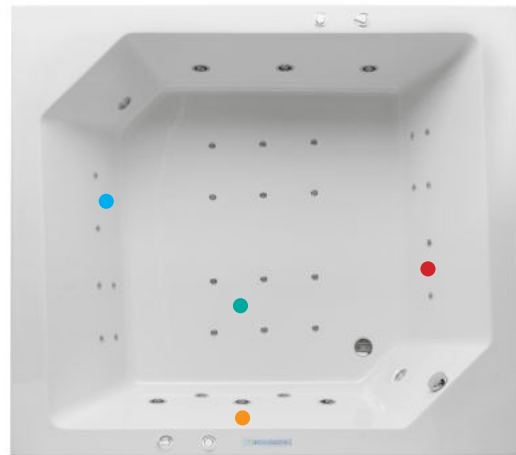

Samson

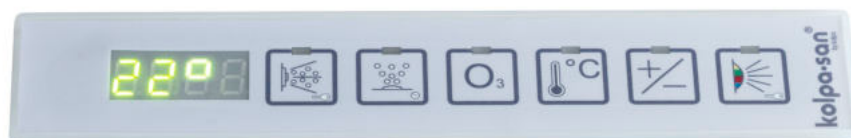

Tristan-FS

kerrock®
HUNGARY

036

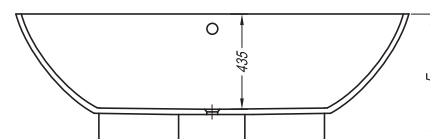
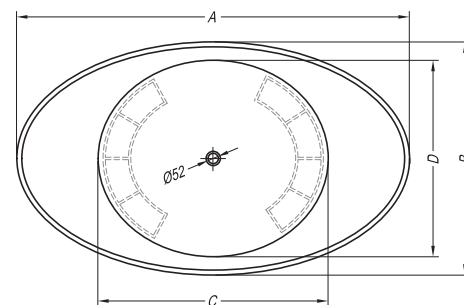

Tristan-FS	A	B	C	D	E	Vol.
197 x 117	1970	1170	1160	990	590	470 l

Tristan-FS 197

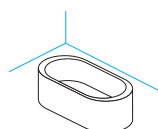
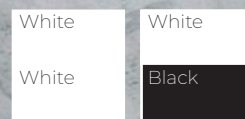

Tristan-FS

- oval freestanding Kerrock bathtub, with chrome overflow set.
- Ovale freistehende Badewanne aus Kerrock, mit verchromter Überlaufgarnitur.
- овальная ванна из Kerrock, отдельно стоящая, с хромированным сливом-переливом.
- ovális szabadon álló Kerrock fürdőkádk króm túlfolyó szettel.

Copelia-FS

kerrock®
BY KOLPA

037

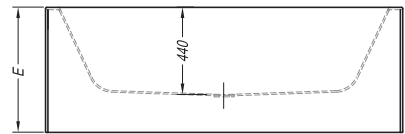
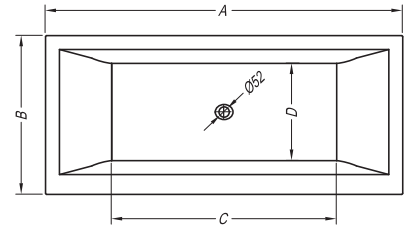
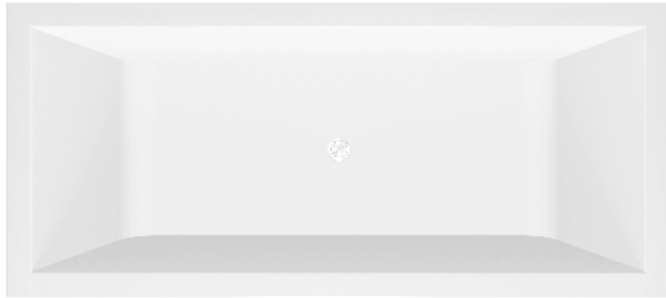

	Copelia-FS	A	B	C	D	E	Vol.
• •	180 x 80	1800	800	1230	490	630	245 l



Copelia-FS 180

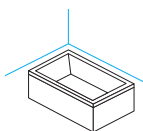

Copelia-FS

- freestanding Kerrock bathtub, outflow set with the UP&DOWN system and automatic overflow.
- freistehende Badewanne aus Kerrock, Ablaufgarnitur mit UP & DOWN System und automatischem Überlauf.
- Свободностоящая ванна из Керрока, со сливом, системой UP&DOWN (вверх и вниз) и автоматическим переливом.
- Szabadon álló Kerrock fürdőkád, lefolyó garnitúra, UP&DOWN rendszer lefolyó szifonnal és automatikus túlfolyóval.

Copelia LUX-FS

kerrock®
HUNGARY

038

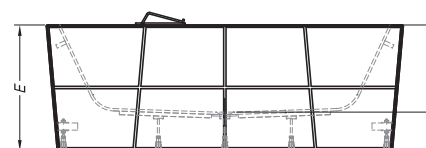
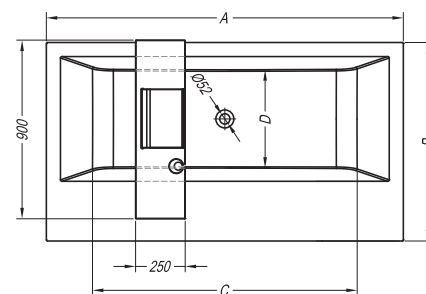

Copelia LUX-FS	A	B	C	D	E	Vol.
180 x 100	1800	1000	1330	495	630	245 l

Copelia LUX-FS 180

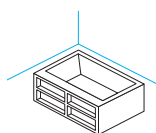

Copelia LUX-FS

- freestanding Kerrock bathtub with shelves and a tub shelf, outflow set with the UP&DOWN system and automatic overflow.
- freistehende Badewanne aus Kerrock, mit integriertem Regal und Badewannenablage, Ablaufgarnitur mit UP&DOWN System und automatischem Überlauf.
- свободностоящая ванна из материала Kerrock с полками и полочкой для ванны, со сливом, системой UP&DOWN и автоматическим переливом.
- szabadon álló Kerrock fürdőkád polcokkal és egy fürdőkádra szerelhető polccal, lefolyó garnitúra, UP&DOWN rendszer lefolyó szifonnal és automatikus túlfolyóval.

Copelia LIGHT-FS

kerrock®
BY KOLPA

039

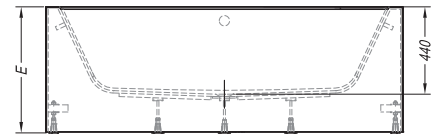
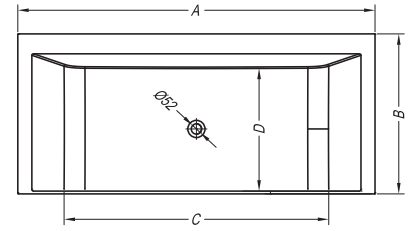

	Copelia LIGHT-FS	A	B	C	D	E	Vol.
•	180 x 80	1800	800	1330	686	600	310 l



Copelia LIGHT-FS 180

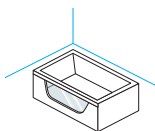

Copelia LIGHT-FS / *Copelia LIGHT-FS + CTL / **Copelia LIGHT-FS/M + CTL

- freestanding Kerrock bathtub with transparent acrylic wall, outflow-overflow set with the UP&DOWN system,

*CTL - chromotherapy with 2 RGB lights, **M+ CTL - air massage system - chromotherapy with 2 RGB lights.

- freistehende Badewanne aus Kerrock, Ab- und Überlaufgarnitur mit UP & DOWN System,

*CTL - Chromotherapie-Programm mit 2 RGB-LEDs, **M+ CTL - Luftmassagesystem - Chromotherapie-Programm mit 2 RGB-LEDs.

- Свободностоящая ванна из материала Kerrock с прозрачной акриловой стенкой, со сливом-переливом и системой UP&DOWN (вверх и вниз).

*CTL - встроенная хромотерапия, 2 светодиода RGB, **M+ CTL - система воздушного массажа - встроенная хромотерапия, 2 светодиода RGB.

- Szabadon álló Kerrock fürdőkád átlátszó akrilfallal, UP&DOWN rendszer lefolyó szifonnal.

*CTL - kromoterápia, 2 RGB fényel, **M+ CTL - légmasszázs rendszer - kromoterápia, 2 RGB fényel.

Gloria-FS

kerrock®
HUNGARY

040

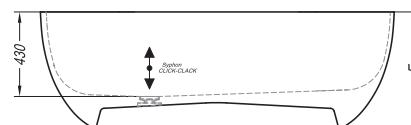
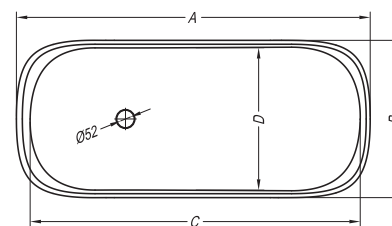

Gloria-FS	A	B	C	D	E	Vol.
180 x 80	1800	800	1295	720	595	340 l

Gloria-FS 180

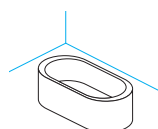
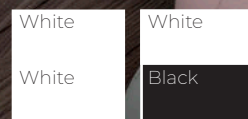

Gloria-FS

- oval freestanding Kerrock bathtub, outflow set with the UP&DOWN system.
- Ovale freistehende Badewanne aus Kerrock, Ab- und Überlaufgarnitur mit UP & DOWN System.
- овальная ванна из Kerrock, отдельно стоящая, со сливом-переливом и системой UP & DOWN.
- Ovális szabadon álló Kerrock fürdőkád, UP&DOWN rendszer lefolyó szifonnal és automatikus túlfolyóval

Blanche-FS

kerrock®
BY KOLPA

041

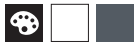
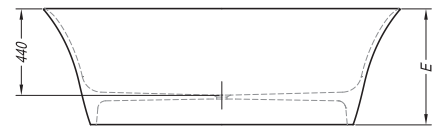
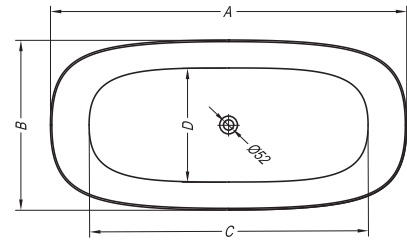

Blanche-FS	A	B	C	D	E	Vol.
180 x 85	1810	860	1420	580	590	280 l



Blanche-FS 180

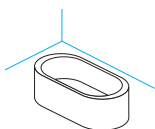
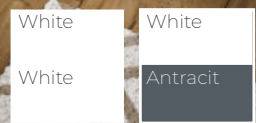

Blanche-FS

- oval freestanding Kerrock bathtub, outflow set with the UP&DOWN system.
- Ovale freistehende Badewanne aus Kerrock, Ab- und Überlaufgarnitur mit UP & DOWN System.
- овальная ванна из Kerrock, отдельно стоящая, со сливом-переливом и системой UP & DOWN.
- Ovális szabadon álló Kerrock fürdőkád, UP&DOWN rendszer lefolyó szifonnal és automatikus túlfolyóval

Ramona bathtub-FS

kerrock
HUNGARY

042

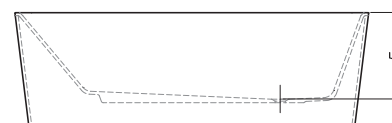
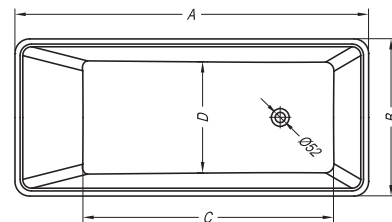
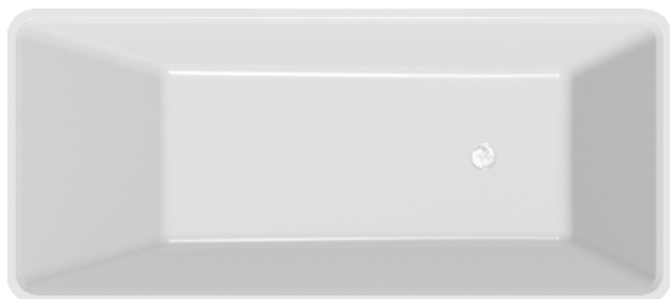

Ramona bathtub-FS	A	B	C	D	E	Vol.
180 x 80	1800	800	1275	565	570	300 l

Ramona bathtub-FS 180

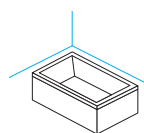

Ramona bathtub-FS

- freestanding Kerrock bathtub, outflow set with the UP&DOWN system.
- freistehende Kerrock-Badewanne, Ablaufgarnitur mit UP&DOWN-System.
- свободностоящая ванна из керрока, со сливом-переливом и системой UP & DOWN.
- kerrock anyagból készült önálló fürdőkádk (108-as színű), UP&DOWN rendszerű lefolyórendszerrel.

Atys DUO-FS

kerrock®
by KOLPA

043

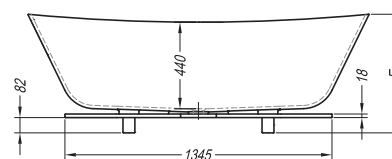
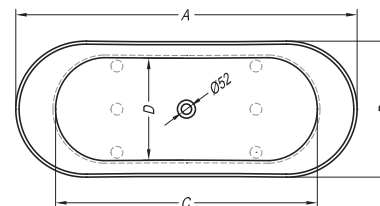

Atys DUO-FS	A	B	C	D	E	Vol.
174 x 70	1735	700	1320	515	600	225 l



Atys DUO-FS 174

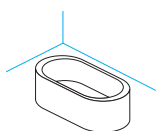

Atys DUO-FS

- freestanding Kerrock bathtub, outflow set with the UP&DOWN system. Colour of the panel: BLACK
- freistehende Badewanne aus Kerrock, Ablaufgarnitur mit UP & DOWN System. Farbe der Platte: BLACK
- szabadonálló Kerrock fürdőkád, kifolyó garnitúra, UP&DOWN rendszer lefolyó szifonnal. A panel színe: BLACK

Atys-FS

kerrock®
HUNGARY

044

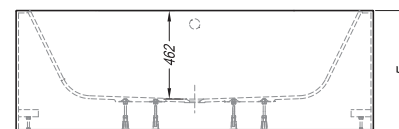
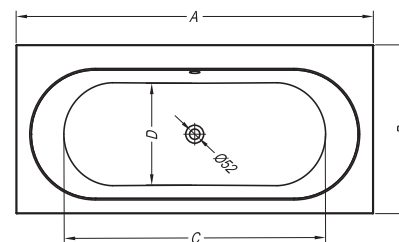

	Atys-FS	A	B	C	D	E	Vol.
•	180 x 85	1800	850	1320	515	600	225 l

Atys-FS 180

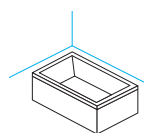

Atys-FS

- freestanding Kerrock bathtub, outflow-overflow set with the UP&DOWN system.
- freistehende Badewanne aus Kerrock, Ab- und Überlaufgarnitur mit UP & DOWN System.
- свободнoстоящая ванна из Керрока, с переливным сливом и системой UP&DOWN (вверх-вниз).
- szabadon álló Kerrock fürdőkádk, kifolyó - túlfolyó garnitúra, UP&DOWN rendszer lefolyó szifonnal.

Atys 180x85/O ^{new}

kerrock®
BY KOLPA

045

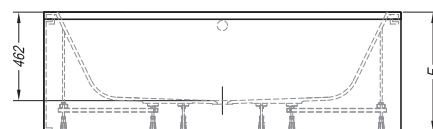
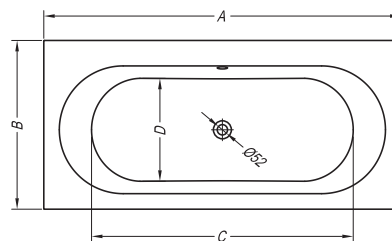
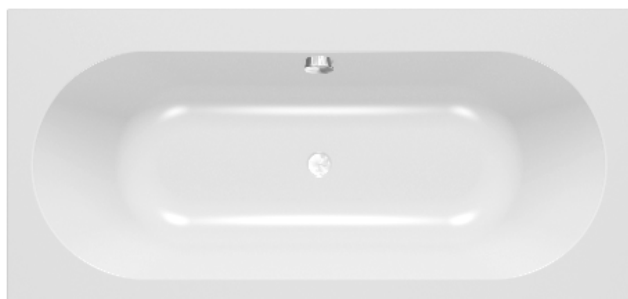

	Atys/O	A	B	C	D	E	Vol.
•	180 x 85	1800	850	1320	515	600	225 l



Atys 180/O

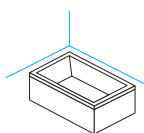

Atys/O

- freestanding Kerrock bathtub with panel, outflow-overflow set with the UP&DOWN system.
- freistehende Badewanne aus Kerrock mit Schürze, Ab- und Überlaufgarnitur mit UP & DOWN System.
- свободностоящая ванна с панелью из Керрока, с переливным сливом и системой UP&DOWN (вверх-вниз).
- szabadon álló Kerrock fürdőkád előlappal, kifolyó - túlfolyó garnitúra, UP&DOWN rendszer lefolyó szifonnal.

Atys

kerrock®
HUNGARY

046

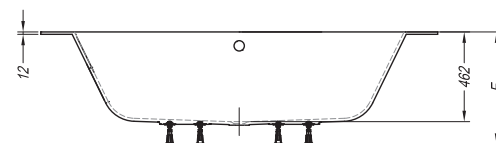
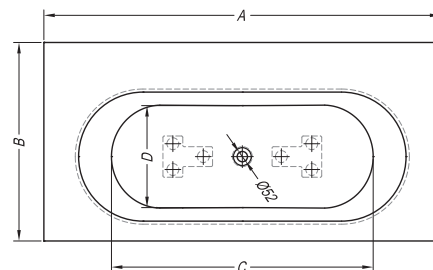

	Atys	A	B	C	D	E	Vol.
•	200 x 100	2000	1000	1320	515	600	225 l



Atys 200

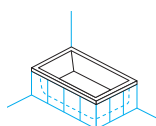

Atys

- kerrock bathtub, outflow-overflow set with the UP&DOWN system, installation on tiles or in tile-level, possibility of trimming the edge of the bathtub.
- Badewanne aus Kerrock, Ab- und Überlaufgarnitur mit UP & DOWN System, Badewanneneinbau auf Bodenfliesen bzw. aufs Bodenfliesen-Niveau, die Badewannenränder können nach Maß zugeschnitten werden.
- ванна из Керрока, со сливом-переливом и системой UP&DOWN (вверх и вниз), установка на плитку, т.е. на уровне плитки, воз-можность среза края ванны.
- kerrock fürdőkádk, padlóra szerelt fürdőkádk, egyedi lapok szerelési lehetősége, kifolyó - túlfolyó garnitúra, UP&DOWN rendszer lefolyó szifonnal.

Milo bathtub-FS

047

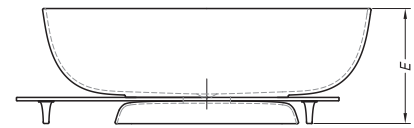
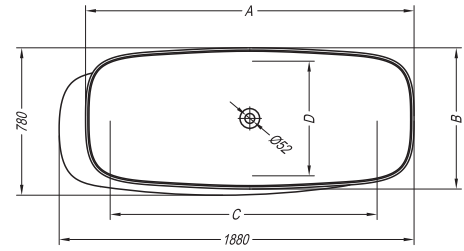

Milo bathtub-FS	A	B	C	D	E	Vol.
174 x 75	1740	750	1550	650	610	275 l



White	White	White
White	Black	Pigeon blue
White	White	White
Leaf green	Vermillion red	Sand

Milo bathtub-FS 174

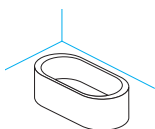

Milo bathtub-FS

- freestanding Kerrock bathtub, outflow set with the UP&DOWN system.
- freistehende Badewanne aus Kerrock, Ablaufgarnitur mit UP & DOWN System.
- свободностоящая ванна из Керрока, со сливом и системой UP&DO WN (вверх и вниз).
- szabadon álló Kerrock fürdőkád, kifolyó garnitúra, UP&DOWN rendszer lefolyó szifonnal.

Boul bathtub-FS

048

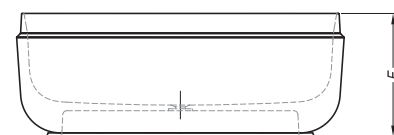
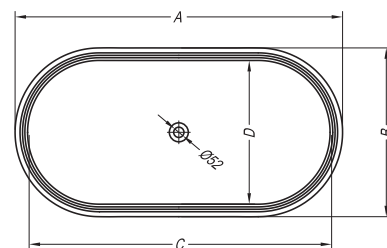

Boul bathtub-FS	A	B	C	D	E	Vol.
165 x 85	1650	850	1525	725	610	335 l

Boul bathtub-FS 165



White	White	White
White	Black	Sand

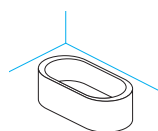

Boul bathtub-FS

- freestanding Kerrock bathtub, outflow set with the UP&DOWN system.
- freistehende Badewanne aus Kerrock, Ablaufgarnitur mit UP & DOWN System.
- свободнoстоящая ванна из Керрока, со сливом и системой UP&DO WN (вверх и вниз).
- szabadon álló Kerrock fürdőkád, kifolyó garnitúra, UP&DOWN rendszer lefolyó szifonnal.

Adam & Eva-FS

049

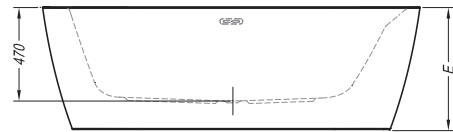
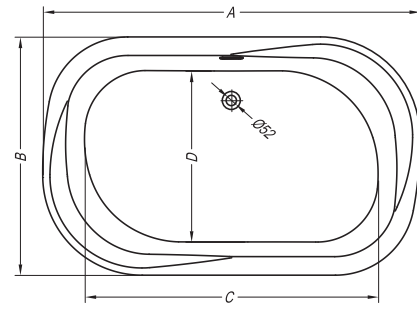

Adam & Eva-FS		A	B	C	D	E	Vol.
•	190 x 120	1900	1200	1450	860	620	450 l



Adam & Eva-FS 190

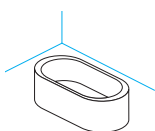

Adam & Eva-FS

- oval bathtub, freestanding, with overflow assembly. The bathtub and side panels from a single element.
- Ovale freistehende Badewanne mit Überlaufgarnitur. Badewanne und Schürze aus einem Teil.
- овальная автономная ванна с системой слива. Ванна и обшивка являются одним целым.
- ovális fürdőkád, önálló, túlfolyó készlettel. Kád és burkolat egyben.

Comodo-FS

050

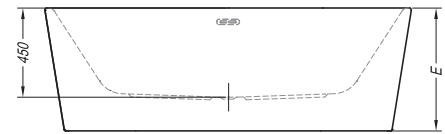
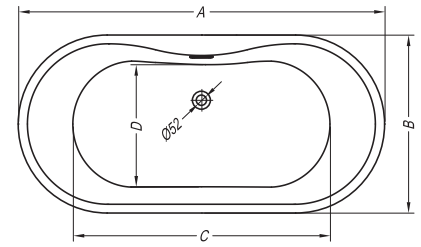

Comodo-FS			A	B	C	D	E	Vol.	
•	•	•	185 x 90	1850	900	1295	615	630	285 l

Comodo-FS 185

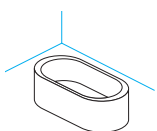

Comodo-FS

- oval bathtub, freestanding, with overflow assembly. The bathtub and side panels from a single element.
- Ovale freistehende Badewanne mit Überlaufgarnitur. Badewanne und Schürze aus einem Teil.
- овальная автономная ванна с системой слива. Ванна и обшивка являются одним целым.
- ovális fürdőkád, önálló, túlfolyó készlettel. Kád és burkolat egyben.

SOFT-FS^{new}

051

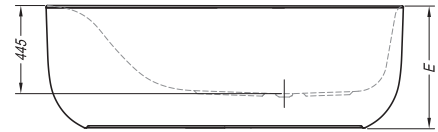
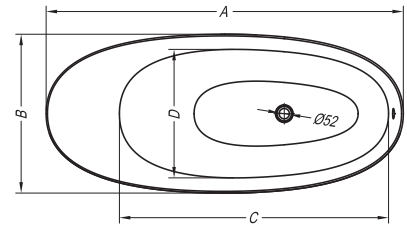

Soft-FS	A	B	C	D	E	Vol.
180 x 80	1800	800	1355	650	618	205 l



Soft-FS 180

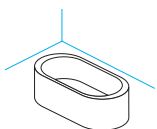

Soft-FS

- oval bathtub, freestanding, outflow set with the UP&DOWN system in white. The bathtub and side panels from a single element.
- Ovale freistehende Badewanne, Ablaufgarnitur mit einem UP & DOWN-System weißer Farbe. Badewanne und Schürze aus einem Teil.
- овальная автономная ванна со сливной гарнитура с системой UP & DOWN белого цвета). Ванна и обшивка являются одним целым.
- ovális fürdőkád, önálló, lefolyókészlet UP & DOWN rendszerrel fehér színben. Kád és burkolat egyben.

SOFT ^{new}

052

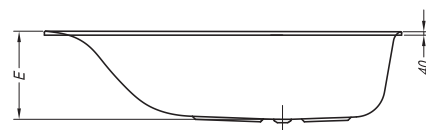
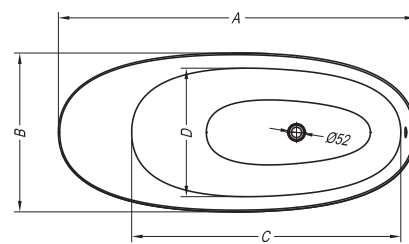

Soft	A	B	C	D	E	Vol.
180 x 80	1800	800	1355	650	445	205 l

Soft 180

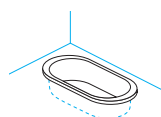

- Soft
- bathtub, built-in.
 - badewanne, zum Einbau.
 - встраиваемая ванна..
 - beépíthető fürdőkád.

Marilyn-FS

053

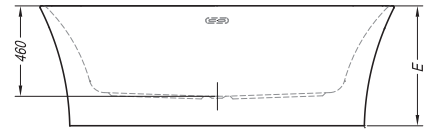
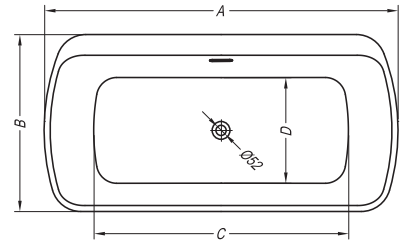

	Marilyn-FS	A	B	C	D	E	Vol.
•	180 x 90	1800	900	1295	540	615	260 l

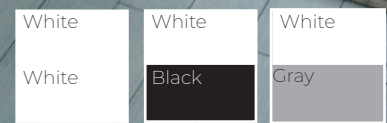

Marilyn-FS 180

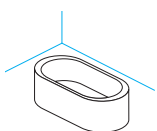

Marilyn-FS
 - bathtub, freestanding, with overflow assembly. The bathtub and side panels from a single element.
 - badewanne, freistehend, mit Überlaufgarnitur. Badewanne und Schürze aus einem Teil.
 - автономная ванна с системой слива. Ванна и обшивка являются одним целым.
 - fürdőkád, önálló, túlfolyó szettel. Kád és burkolat egyben.

Pandora-FS

054

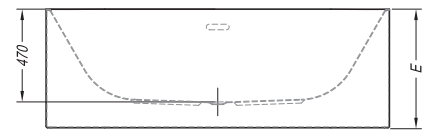
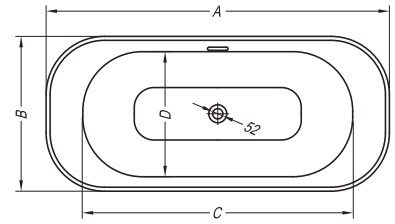

Pandora-FS	A	B	C	D	E	Vol.
173 x 78	1730	780	1360	630	605	285 l
163 x 68	1630	680	1260	530	605	230 l

Pandora-FS 173, 163

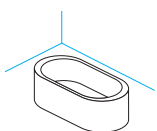

Pandora-FS

- oval bathtub, freestanding, overflow set with the UP&DOWN system. The bathtub and side panels from a single element.
- ovale Badewanne, freistehend, Überlaufgarnitur mit UP & DOWN System. Badewanne und Schürze aus einem Teil.
- овальная автономная ванна со переливом и системой UP&DOWN (вверх и вниз). Ванна и обшивка являются одним целым.
- ovális fürdőkád, önálló, túlfolyó garnitúra, UP&DOWN rendszer lefolyó szifonnal. Kád és burkolat egyben.

Dalia-FS

055

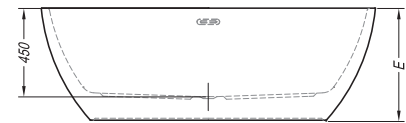
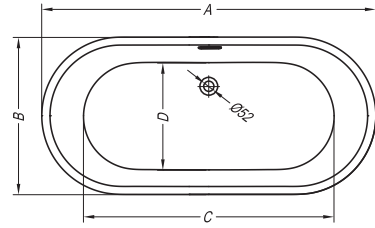

Dalia-FS	A	B	C	D	E	Vol.
170 x 80	1700	800	1275	545	575	275 l

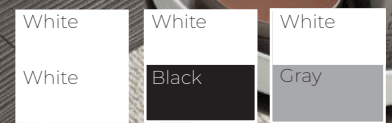

Dalia-FS 170

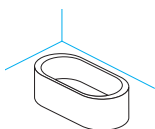

Dalia-FS

- bathtub, freestanding, with overflow assembly. The bathtub and side panels from a single element.
- badewanne, freistehend, mit Überlaufgarnitur. Badewanne und Schürze aus einem Teil.
- автономная ванна с системой слива. Ванна и обшивка являются одним целым.
- fürdőkád, önálló, túlfolyó szettel. Kád és burkolat egyben.

LUX-FS ^{new}

056

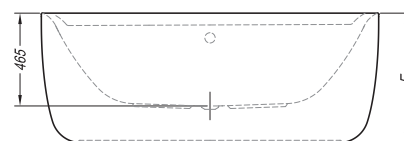
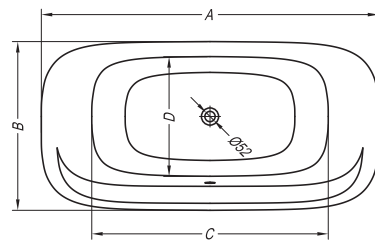

	Lux-FS	A	B	C	D	E	Vol.
•	170 x 85	1700	850	1200	600	655	215 l

Lux-FS 170

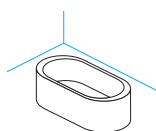

Lux-FS
 - oval bathtub, freestanding, outflow set with the UP&DOWN system in white. The bathtub and side panels from a single element.
 - ovale Badewanne, freistehend, Ablaufgarnitur mit einem UP & DOWN-System weißer Farbe. Badewanne und Schürze aus einem Teil.
 - овальная автономная ванна со сливной гарнитурой с системой UP & DOWN белого цвета). Ванна и обшивка являются одним целым.
 - ovális fürdőkádkak, önálló, lefolyókészlet UP & DOWN rendszerrel fehér színben. Kád és burkolat egyben.

LUX ^{new}

057

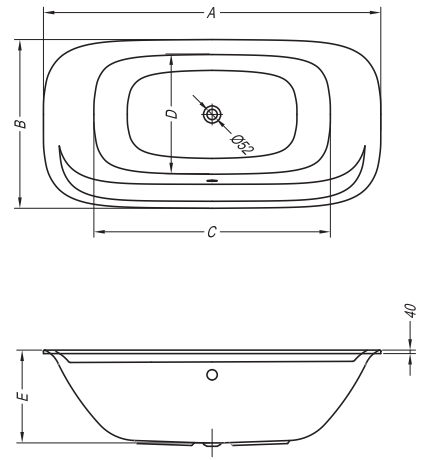

Lux	A	B	C	D	E	Vol.
170 x 85	1700	850	1200	600	465	215 l



Lux 170

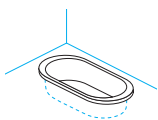

Lux
 - bathtub, built-in.
 - Badewanne, zum Einbau.
 - встраиваемая ванна.
 - beépíthető fürdőkádkak.

Elektra-SP ^{new}

058

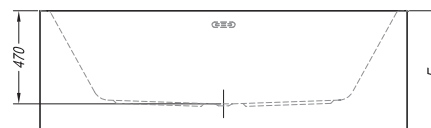
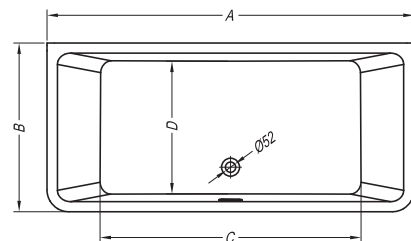

Elektra-SP	A	B	C	D	E	Vol.
185 x 85	1850	850	1345	640	620	360 l
175 x 75	1750	750	1200	540	620	265 l

Elektra-SP 185, 175



Elektra-SP

- bathtub for wall installation with an overflow fitting. The bathtub and the panel made of a single piece.
- Badewanne für die Montage an der Wand mit einer Überlaufgarnitur. Badewanne und Schürze aus einem Teil.
- ванна, для пристенной установки. Панель интегрирована в корпус Ванны.
- fürdőkád le- és túlfolyó garnitúrával, falhoz állítható. A kád és az előlap egy részből áll.



Dream-SP

059

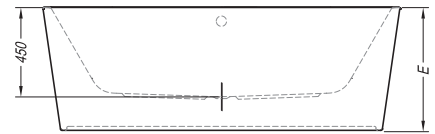
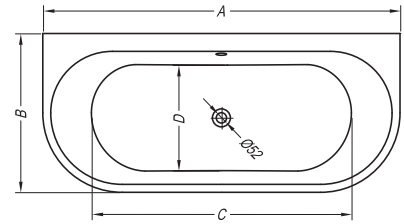

	Dream-SP	A	B	C	D	E	Vol.
• • •	180 x 80	1800	800	1310	530	625	245 l
• • •	170 x 75	1700	750	1285	515	625	215 l



Dream-SP 180, 170



Dream-SP

- oval bathtub for wall installation with an overflow fitting. The bathtub and the panel made of a single piece.
- Ovale Badewanne für die Montage an der Wand mit einer Überlaufgarnitur. Badewanne und Schürze aus einem Teil.
- овальная ванна, для пристенной установки. Панель интегрирована в корпус Ванны.
- ovális fürdőkád le- és túlfolyó garnitúrával, falhoz állítható. A kád és az előlap egy részből áll.

Opera

060

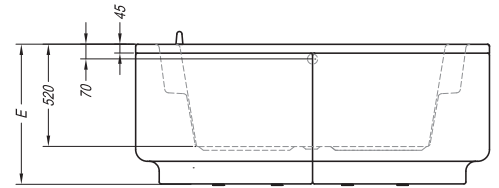
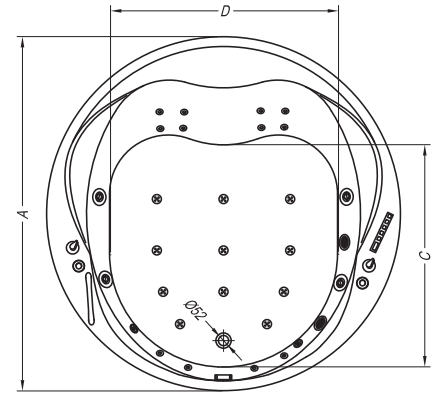

Opera		A	B	C	D	E	Vol.
• •	180 x 180	1800	1800	1130	1160	710	570 l
• •	180 x 180 (O)	1800	1800	1130	1160	710	570 l

Opera 180

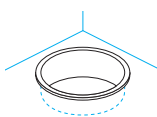

Opera
 - round massage bathtub with a handle, for built-in installation.
 - runde Massagebadewanne mit Griff, für den Einbau.
 - круглая гидромассажная ванна с ручкой, для встраивания.
 - beéríthető kör alakú masszázs fürdőkádk kapacskodóval.

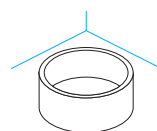

Opera/O
 - round massage bathtub with a handle and a panel.
 - runde Massagebadewanne mit Griff und Verkleidung.
 - круглая гидромассажная ванна с ручкой и панелями.
 - előlappos kör alakú masszázs fürdőkádk kapacskodóval.

Gaia

061

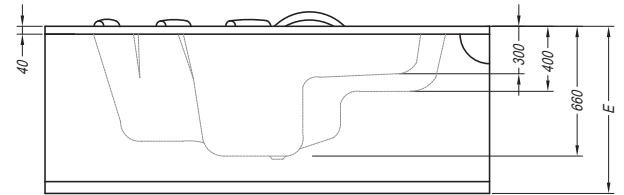
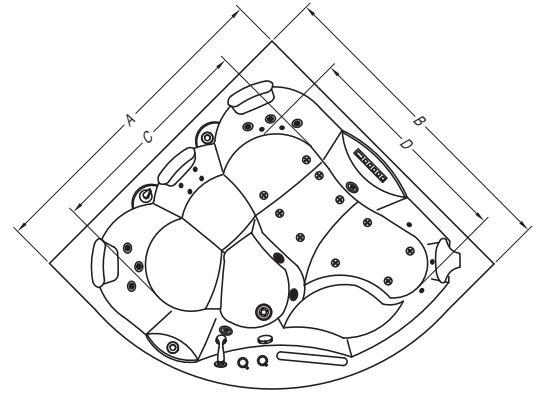

	Gaia	A	B	C	D	E	Vol.
• • •	160 x 160	1600	1600	1350	1250	850	550 l
• • •	160 x 160 (O)	1600	1600	1350	1250	850	550 l



Gaia 160

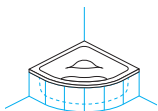

Gaia
 - corner massage bathtub for built-in installation with a single-hand mixer and a shower handle.
 - eckmassagebadewanne für den Einbau mit einarmiger Armatur und Duschgriff.
 - угловая гидромассажная ванна для встраивания, со встроенным смесителем.
 - beépíthető sarok masszázsfürdőkád csapteleppel és kézizuhannyal.

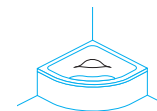

- seat
 - Sitz
 - сиденье
 - ülés

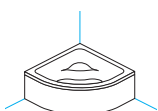

Gaia/O
 - corner massage bathtub with a panel, single-hand mixer and shower handle.
 - eckmassagebadewanne mit Verkleidung, einarmiger Armatur und Duschgriff
 - угловая гидромассажная ванна для встраивания, со встроенным смесителем и панелью
 - előlapos sarok masszázsfürdőkád csapteleppel és kézizuhannyal.

Dolores ^{new}

062

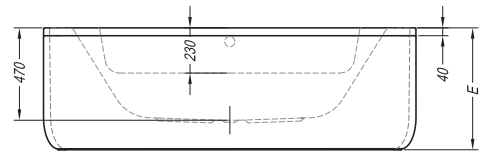
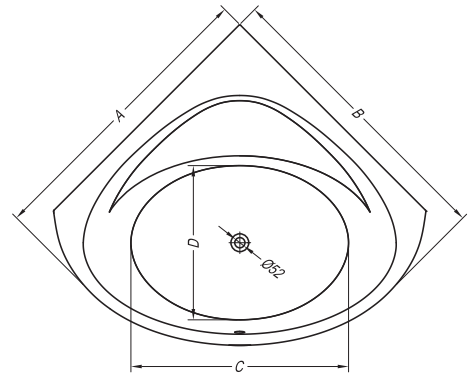

• • •	Dolores	A	B	C	D	E	Vol.
•	150 x 150	1500	1500	1180	810	470	330 l
• • •	150 x 150 (O)	1500	1500	1180	810	640	330 l
•	140 x 140	1400	1400	1070	730	470	280 l
• • •	140 x 140 (O)	1400	1400	1070	730	640	280 l
•	130 x 130	1300	1300	1070	660	470	240 l
•	130 x 130 (O)	1300	1300	1070	660	640	240 l

Dolores 150, 140, 130

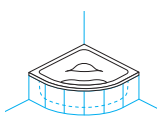

Dolores
 - corner bathtub, built-in.
 - eckbadewanne, zum Einbau.
 - угловая ванна, встраиваемая.
 - beépíthető sarokkád.

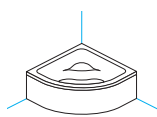

Dolores/O
 - corner bathtub with panel.
 - eckbadewanne mit Schürze.
 - угловая ванна с панелью.
 - sarokkád előlappal.

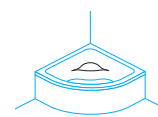

- seat
 - Sitz
 - сиденье
 - ülés

Divante

063

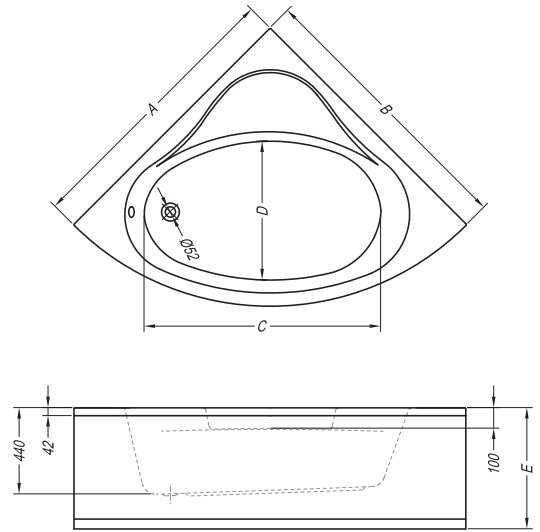

	Divante	A	B	C	D	E	Vol.
•	140 x 140	1400	1400	1200	705	440	240 l
• • •	140 x 140 (O)	1400	1400	1200	705	620	240 l



Divante 140

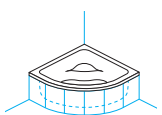

Divante
 - corner bathtub, built-in.
 - eckbadewanne, zum Einbau.
 - угловая ванна, встраиваемая.
 - beépíthető sarokkád.

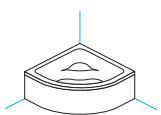

Divante/O
 - corner bathtub with panel.
 - eckbadewanne mit Schürze.
 - угловая ванна с панелью.
 - sarokkád előlappal.

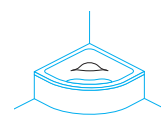

- seat
 - Sitz
 - сиденье
 - ülés

Royal

064

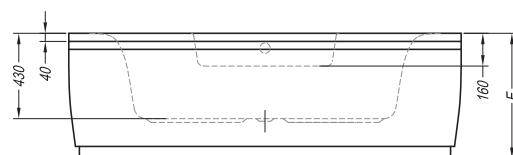
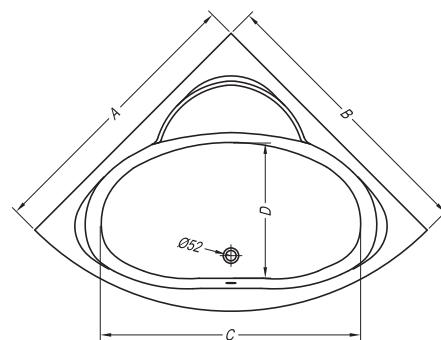

	Royal	A	B	C	D	E	Vol.
•	130 x 130	1300	1300	1090	630	430	220 l
• •	130 x 130 (O)	1300	1300	1090	630	640	220 l
•	120 x 120	1200	1200	1050	595	430	180 l
•	120 x 120 (O)	1200	1200	1050	595	620	180 l

Royal 130, 120

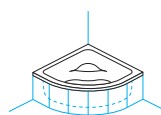

Royal
 - corner bathtub, built-in.
 - eckbadewanne, zum Einbau.
 - угловая ванна, встраиваемая.
 - beépíthető sarokkád.

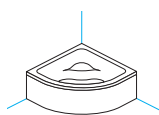

Royal/O
 - corner bathtub with panel.
 - eckbadewanne mit Schürze.
 - угловая ванна с панелью.
 - sarokkád előlappal.

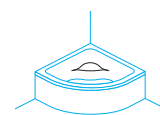

- seat
 - Sitz
 - сиденье
 - ülés

Elektra-SP - L,R ^{new}

065



Elektra-SP -L

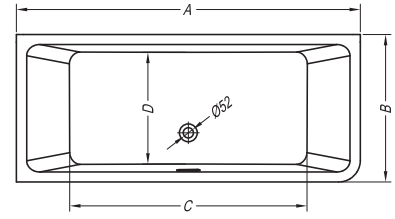
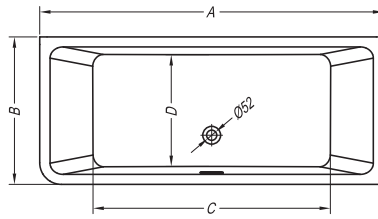

Elektra-SP -R

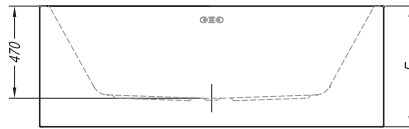

Elektra-SP -L

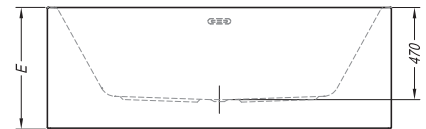

Elektra-SP -R



Elektra-SP	A	B	C	D	E	Vol.
185 x 85	1850	850	1345	640	620	360 l
175 x 75	1750	750	1200	540	620	265 l



Elektra-SP -R

Elektra-SP - L,R 185,175

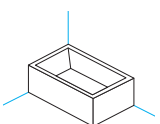

Elektra-SP

- bathtub with overflow assembly. The bathtub and side panels from a single element.
- badewanne mit Überlaufgarnitur. Badewanne und Verkleidung in einem.
- ванна с системой слива. Ванна и обшивка являются одним целым.
- fürdőkád túlfolyó szettel. Kád és burkolat egyben.

Dream-SP ^{new}

066



Dream-SP - L

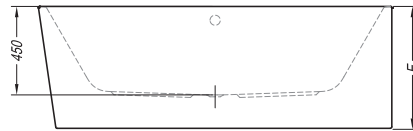
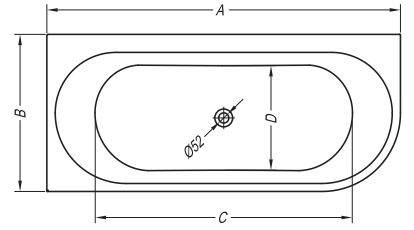
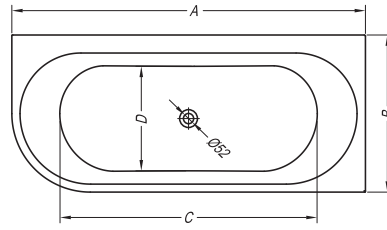

Dream-SP - L

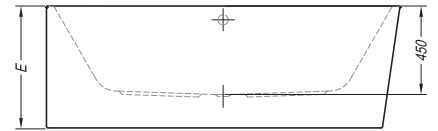

Dream-SP - R

Dream-SP - R



	Dream-SP	A	B	C	D	E	Vol.
• • •	180 x 80	1800	800	1310	530	625	285 l
• • •	170 x 75	1700	750	1285	515	625	225 l

Dream-SP 180,170

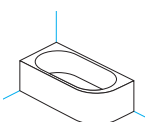

Dream-SP

- asymmetric bathtub with overflow assembly. The bathtub and side panels from a single element.
- asymmetrische Badewanne bathtub mit einer Überlaufgarnitur. Badewanne und Verkleidung aus einem Teil.
- асимметричная ванна с системой слива. Панель интегрирована в корпус Ванны.
- aszimmetrikus fürdőkád túlfolyó készlettel. A kád és az előlap egy részből áll.

Libretto ^{new}



Libretto - L



Libretto - R

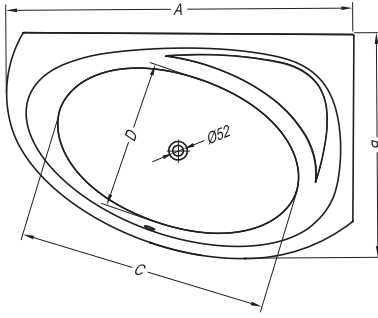

Libretto - L

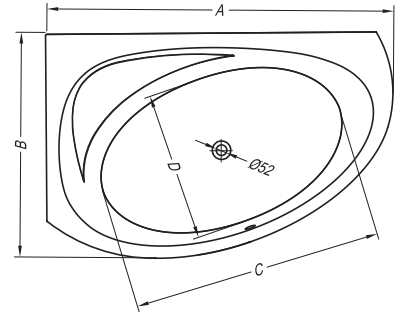

Libretto - R

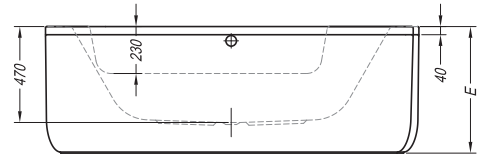
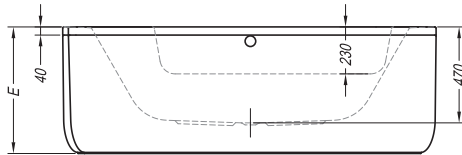

•	•	•	Libretto	A	B	C	D	E	Vol.
•			170 x 110	1700	1100	1170	730	470	285 l
•	•	•	170 x 110 (O)	1700	1100	1170	730	640	285 l
•			160 x 100	1600	1000	1135	650	470	230 l
•	•	•	160 x 100 (O)	1600	1000	1135	650	640	230 l

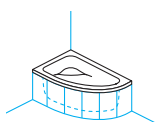

Libretto

- asymmetric bathtub, built-in.
- asymmetrische Badewanne, zum Einbau.
- асимметричная ванна, встраиваемая.
- aszimmetrikus beépíthető fürdőkád.

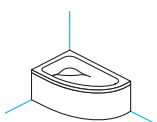

Libretto/O

- asymmetric bathtub with panel.
- asymmetrische Badewanne mit Schürze.
- асимметричная ванна с панелью.
- aszimmetrikus fürdőkád előlappal.

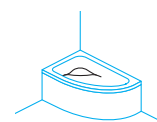

- seat
- Sitz
- сиденье
- ülés

Beatrice

068



Beatrice - L



Beatrice - R

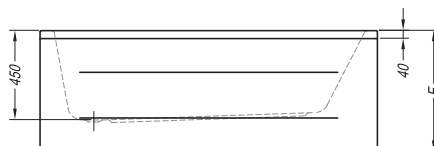
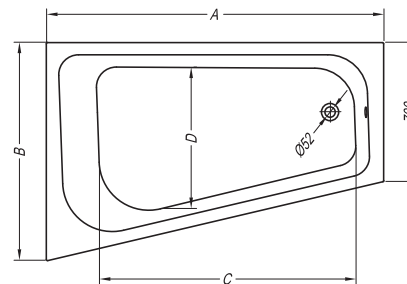
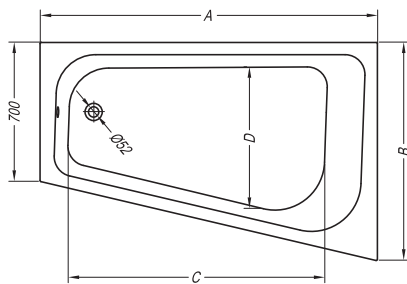

Beatrice - L

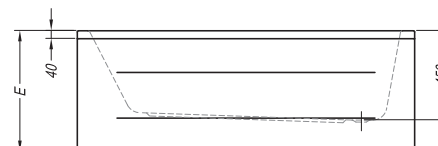

Beatrice - R



Icon	Beatrice	A	B	C	D	E	Vol.
•	170 x 110	1700	1100	1280	720	450	305 l
• •	170 x 110 (O)	1700	1100	1280	720	610	305 l

Beatrice 170

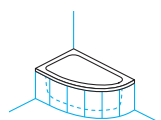

Beatrice
 - asymmetric bathtub, built-in.
 - asymmetrische Badewanne, zum Einbau.
 - асимметричная ванна, встраиваемая.
 - aszimmetrikus beépíthető fürdőkádk.

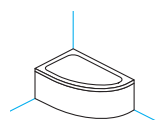

Beatrice/O
 - asymmetric bathtub with panel.
 - asymmetrische Badewanne mit Schürze.
 - асимметричная ванна с панелью.
 - aszimmetrikus fürdőkádk előlappal.

Calando

069



Calando - L

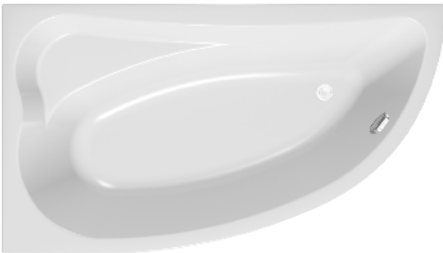
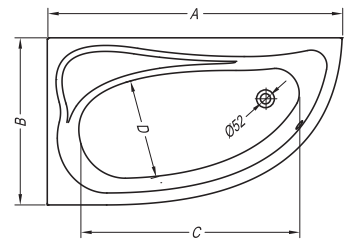
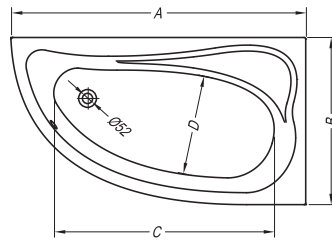

Calando - R

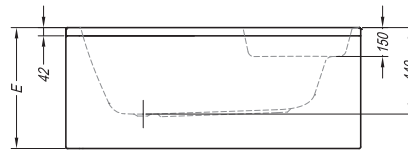

Calando - L

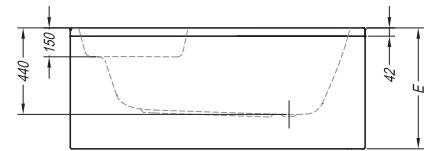

Calando - R



Calando	A	B	C	D	E	Vol.
• 160 x 90	1600	900	1160	730	440	205 l
• • • 160 x 90/O	1600	900	1160	730	615	205 l
• 150 x 85	1500	850	1090	505	440	180 l
• • • 150 x 85/O	1500	850	1090	505	615	180 l



Calando 160, 150

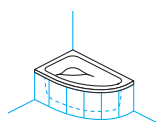

Calando

- asymmetric bathtub, built-in.
- asymmetrische Badewanne, zum Einbau.
- асимметричная ванна, встраиваемая.
- aszimmetrikus beépíthető fürdőkádk.

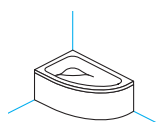

Calando/O

- asymmetric bathtub with panel.
- asymmetrische Badewanne mit Schürze.
- асимметричная ванна с панелью.
- aszimmetrikus fürdőkádk előlappal.

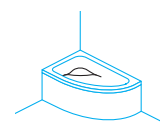

- seat
- Sitz
- сиденье
- ülés

Betty ^{new}

070



Betty 200 - 190

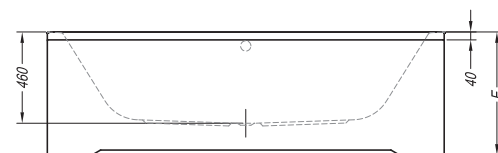
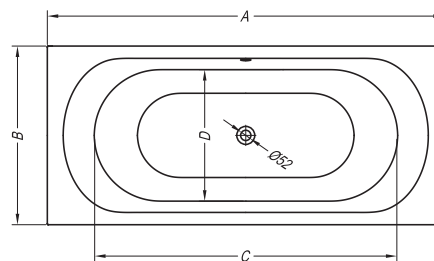

Betty 180 - 120

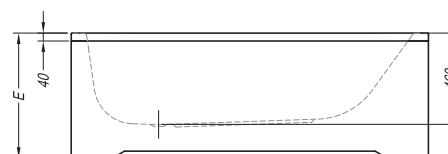
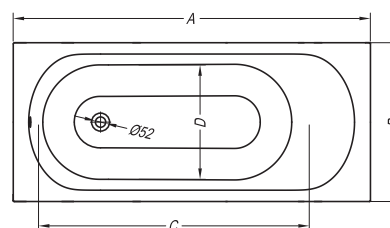

	Betty	A	B	C	D	E	Vol.
•	200 x 90	2000	900	1530	685	460	330 l
•	200 x 90 (O)	2000	900	1530	685	630	330 l
•	190 x 90	1900	900	1430	685	460	310 l
•	190 x 90 (O)	1900	900	1430	685	630	310 l
•	180 x 80	1800	800	1365	580	460	285 l
•	180 x 80 (O)	1800	800	1365	580	630	285 l
•	170 x 80	1700	800	1300	570	460	245 l
•	170 x 80 (O)	1700	800	1300	570	630	245 l
•	170 x 75	1700	750	1300	530	460	235 l
•	170 x 75 (O)	1700	750	1300	530	630	235 l
•	170 x 70	1700	700	1300	490	460	210 l
•	170 x 70 (O)	1700	700	1300	490	630	210 l
•	160 x 70	1600	700	1250	490	460	200 l
•	160 x 70 (O)	1600	700	1250	490	630	200 l
•	150 x 70	1500	700	1140	490	460	180 l
•	150 x 70 (O)	1500	700	1140	490	630	180 l
•	140 x 70	1400	700	1040	490	460	165 l
•	140 x 70 (O)	1400	700	1040	490	630	165 l
•	130 x 70	1300	700	950	490	460	150 l
•	130 x 70 (O)	1300	700	950	490	630	150 l
•	120 x 70	1200	700	870	490	460	135 l
•	120 x 70 (O)	1200	700	870	490	630	135 l



Betty 200, 190



Betty 180 - 120

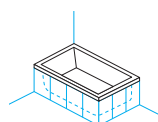

Betty
 - bathtub, built-in.
 - badewanne, zum Einbau.
 - встраиваемая ванна..
 - beépíthető fürdőkád.

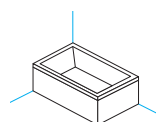

Betty/O
 - bathtub, built-in.
 - badewanne mit Schürze.
 - ванна с панелью.
 - fürdőkád előlappal.

Betty 200, 190, 180, 170, 160, 150, 140, 130, 120

Betty E2 ^{new}

071

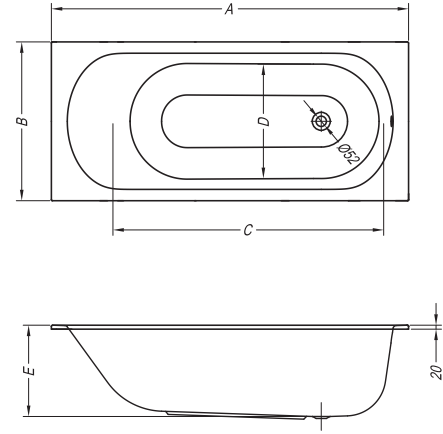

	Betty E2	A	B	C	D	E	Vol.
	180 x 80	1800	800	1365	580	460	285 l
	170 x 80	1700	800	1300	570	460	245 l
•	170 x 75	1700	750	1300	530	460	235 l
•	170 x 70	1700	700	1300	490	460	210 l



Betty E2 180, 170

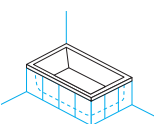

Betty
 - bathtub, built-in.
 - badewanne, zum Einbau.
 - встраиваемая ванна.
 - beépíthető fürdőkádk.

Adam & Eva

072

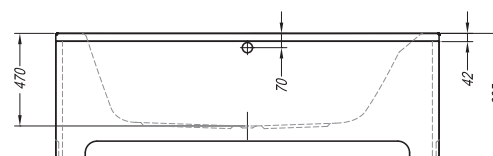
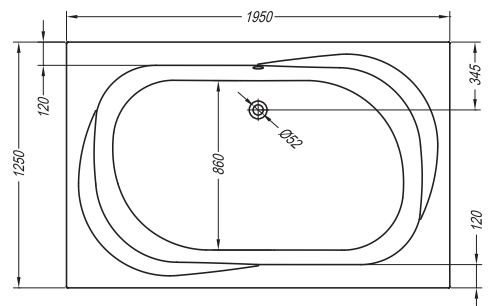

	Adam & Eva	A	B	C	D	E	Vol.
•	195 x 125	1950	1250	1450	862	470	450 l
• • •	195 x 125 (O)	1950	1250	1450	862	635	450 l

Adam & Eva 195

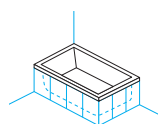

Adam & Eva
 - bathtub, built-in.
 - badewanne, zum Einbau.
 - встраиваемая ванна..
 - beépíthető fürdőkád.

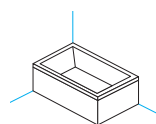

Adam & Eva/O
 - bathtub, built-in.
 - badewanne mit Schürze.
 - ванна с панелью.
 - fürdőkád előlappal.

Nabucco

073

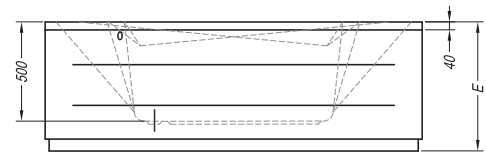
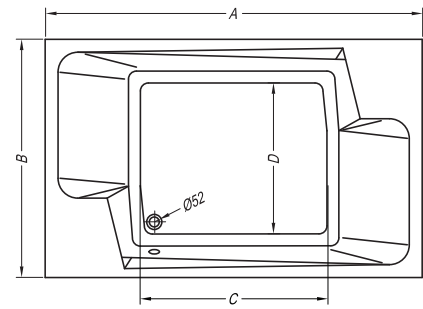

	Nabucco	A	B	C	D	E	Vol.
• •	190 x 120	1900	1200	1050	880	500	450 l
• •	190 x 120 (O)	1900	1200	1050	880	660	450 l



Nabucco 190

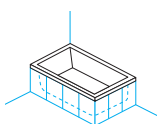

Nabucco
 - bathtub, built-in.
 - badewanne, zum Einbau.
 - встраиваемая ванна.
 - beépíthető fürdőkád.

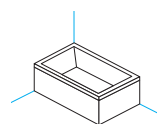

Nabucco/O
 - bathtub with panel.
 - badewanne mit Schürze.
 - ванна с панелью.
 - fürdőkád előlappal.

Elektra

074

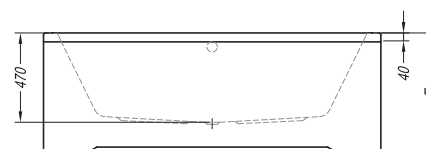
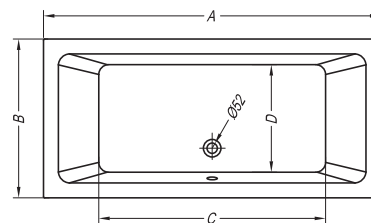

	Elektra	A	B	C	D	E	Vol.
•	190 x 90	1900	900	1345	640	470	360 l
•	• 190 x 90 (O)	1900	900	1345	640	630	360 l
•	180 x 80	1800	800	1200	540	470	265 l
•	• 180 x 80 (O)	1800	800	1200	540	630	265 l
•	170 x 80	1700	800	1145	540	470	245 l
•	• 170 x 80 (O)	1700	800	1145	540	630	245 l
•	• 170 x 75	1700	750	1080	490	470	220 l
•	• • 170 x 75 (O)	1700	750	1080	490	630	220 l
•	• 170 x 70	1700	700	1145	440	470	200 l
•	• • 170 x 70 (O)	1700	700	1145	440	630	200 l
•	• 160 x 75	1600	750	970	490	470	205 l
•	• • 160 x 75 (O)	1600	750	970	490	630	205 l

Elektra 190, 180, 170, 160

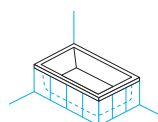

Elektra
 - bathtub, built-in.
 - badewanne, zum Einbau.
 - встраиваемая ванна..
 - beépíthető fürdőkád.

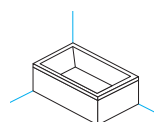

Elektra/O
 - bathtub with panel.
 - badewanne mit Schürze.
 - ванна с панелью.
 - fürdőkád előlappal.

Samson

075

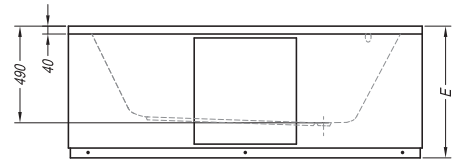
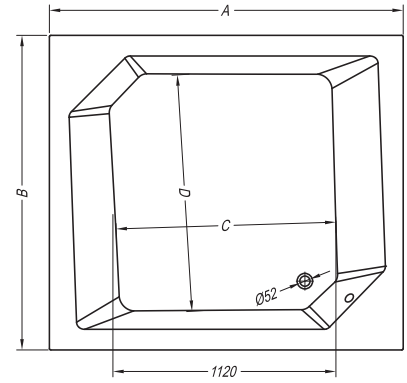

	Samson	A	B	C	D	E	Vol.
• • •	180 x 160	1800	1600	1120	1150	490	650 l
• • •	180 x 160/20	1800	1600	1120	1150	670	650 l
• • •	180 x 160/40	1800	1600	1120	1150	670	650 l



Samson 180

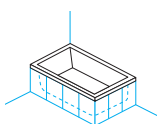

Samson
 - bathtub, built-in.
 - badewanne, zum Einbau.
 - встраиваемая ванна.
 - beépíthető fürdőkád.

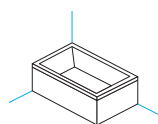

Samson/20
 - bathtub with panel.
 - badewanne mit Schürze.
 - ванна с панелью.
 - fürdőkád előlappal.

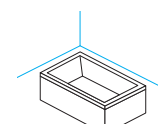

Samson/40
 - free-standing bathtub (4 side panels).
 - freistehende Badewanne (4 Frontschürzen).
 - отдельно стоящая ванна (4 панели).
 - önálló fürdőkád (4 burkolat).

Pandora bathtub

076

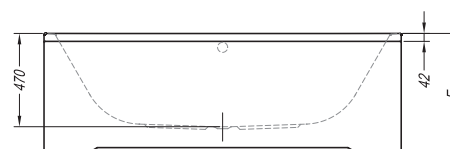
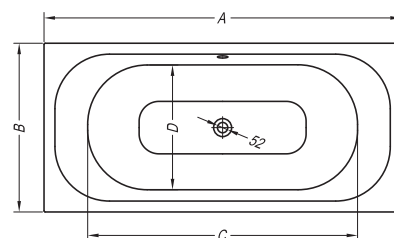
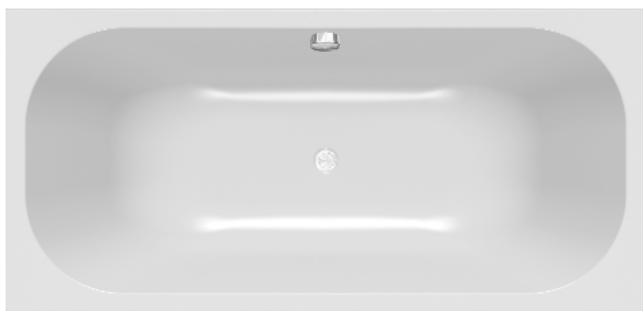

	Pandora bathtub	A	B	C	D	E	Vol.
•	180 x 85	1800	850	1360	630	470	285 l
• • •	180 x 85/O	1800	850	1360	630	630	285 l
•	170 x 75	1700	750	1260	530	470	230 l
• • •	170 x 75/O	1700	750	1260	530	630	230 l

Pandora bathtub 180, 170

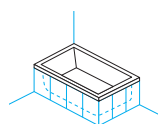

Pandora bathtub
 - bathtub, built-in.
 - badewanne, zum Einbau.
 - встраиваемая ванна..
 - beéríthető fürdőkád.

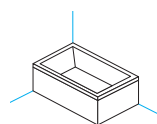

Pandora bathtub/O
 - bathtub with panel.
 - badewanne mit Schürze.
 - ванна с панелью.
 - fürdőkád előlappal.

Evelin bathtub

077

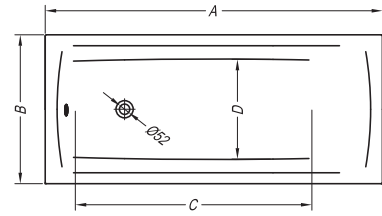

		Evelin bathtub	A	B	C	D	E	Vol.
•	•	170 x 75	1700	750	1195	505	440	200 l
•	•	170 x 75 (O)	1700	750	1195	505	615	200 l
•	•	170 x 70	1700	700	1195	455	440	175 l
•	•	170 x 70 (O)	1700	700	1195	455	615	175 l
•	•	160 x 70	1600	700	1095	455	440	160 l
•	•	160 x 70 (O)	1600	700	1095	455	615	160 l
•	•	150 x 70	1500	700	1010	455	440	150 l
•	•	150 x 70 (O)	1500	700	1010	455	615	150 l
•	•	140 x 70	1400	700	910	455	440	135 l
•	•	140 x 70 (O)	1400	700	910	455	615	135 l

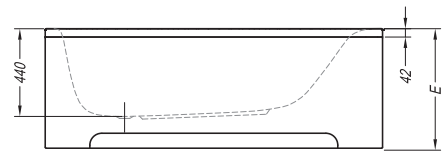

Evelin bathtub 170, 160, 150, 140

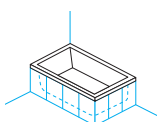

Evelin bathtub
 - bathtub, built-in.
 - badewanne, zum Einbau.
 - встраиваемая ванна.
 - beépíthető fürdőkád.

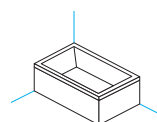

Evelin bathtub/O
 - bathtub with panel.
 - badewanne mit Schürze.
 - ванна с панелью.
 - fürdőkád előlappal.

Tamia

078

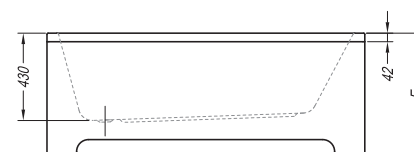
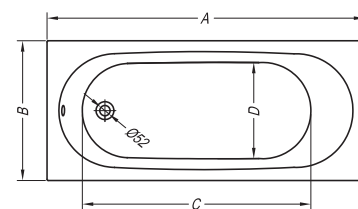

	Tamia	A	B	C	D	E	Vol.
•	180 x 80	1800	800	1290	565	430	255 l
• •	180 x 80 (O)	1800	800	1290	565	615	255 l
• •	170 x 75	1700	750	1290	520	430	230 l
• • •	170 x 75 (O)	1700	750	1290	520	615	230 l
• •	170 x 70	1700	700	1260	480	430	215 l
• • •	170 x 70 (O)	1700	700	1260	480	615	215 l
• •	160 x 70	1600	700	1195	480	430	180 l
• • •	160 x 70 (O)	1600	700	1195	480	615	180 l
• •	150 x 70	1500	700	1100	480	430	170 l
• • •	150 x 70 (O)	1500	700	1100	480	615	170 l
• •	140 x 70	1400	700	1000	480	430	155 l
• • •	140 x 70 (O)	1400	700	1000	480	615	155 l

Tamia 180, 170, 160, 150, 140

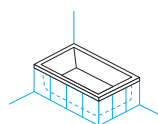

Tamia
 - bathtub, built-in.
 - badewanne, zum Einbau.
 - встраиваемая ванна..
 - beépíthető fürdőkád.

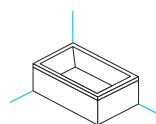

Tamia/O
 - bathtub with panel.
 - badewanne mit Schürze.
 - ванна с панелью.
 - fürdőkád előlappal.

Tamia/S

079

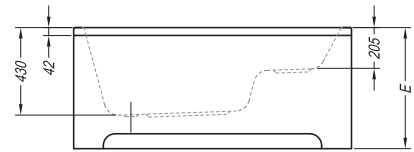
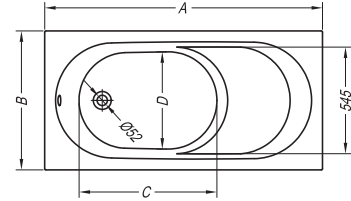

	Tamia/S	A	B	C	D	E	Vol.
•	140 x 70 (O)	1400	700	745	500	615	135 l



Tamia/S 140

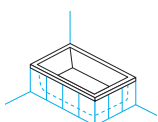

Tamia
 - bathtub, built-in.
 - badewanne, zum Einbau.
 - встраиваемая ванна.
 - beépíthető fürdőkád.

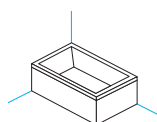

Tamia/SO
 - bathtub with panel.
 - badewanne mit Schürze.
 - ванна с панелью.
 - fürdőkád előlappal.

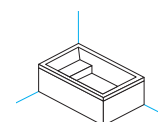

- seat
 - Sitz
 - сиденье
 - ülés

Figaro

080

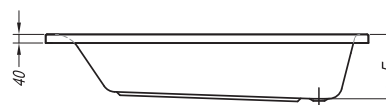
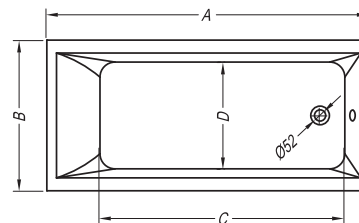

Figaro		A	B	C	D	E	Vol.	
•	•	170 x 75	1700	750	1320	520	300	145 l
•	•	160 x 80	1600	800	1200	600	300	145 l
•	•	150 x 70	1500	700	1110	500	300	120 l

Figaro 170, 160, 150

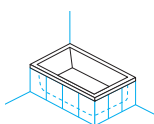

Figaro
 - bathtub, built-in, shallow.
 - badewanne, zum Einbau.
 - встраиваемая ванна, мелкая.
 - beépíthető fürdőkád, sekély.

Mini

081

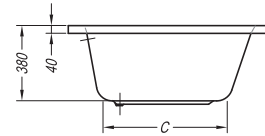
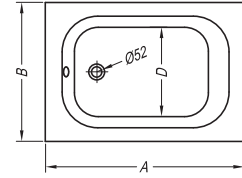

	Mini	A	B	C	D	Vol.
•	100 x 70	1000	700	630	450	110 l



Mini 120

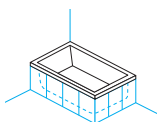

- Mini
- bathtub, built-in.
 - badewanne, zum Einbau.
 - встраиваемая ванна.
 - beépíthető fürdőkád.





Antislip coating

Antislip Beschichtung

Antislip покpытия

Antislip bevonat

083



Antislip

Advantages of the ANTISLIP coating

- Non-slip surface in shower trays and bathtubs
- Developed for bathrooms, wellness and hotel bathrooms

Vorteile RUTSCHFESTE (ANTISLIP) Beschichtung

- rutschfeste Oberfläche bei der Verwendung der Dusch- bzw. Badewannen
- entwickelt für Bade- oder Wellnessräume und Hotelbadezimmer

Преимущества ANTISLIP (антискользящего) покрытия

- нескользящая поверхность во время пользования ванной или душевой кабиной
- разработано для ванных и велнес помещений, а также для гостиничных ванных комнат

Az ANTISLIP bevonat előnyei

- a zuhanykád, illetve fürdőkád nem csúszik
- a fürdőszobai, wellness és hotelfürdőszobákra volt kifejlesztve

Improved safety:

- When entering or exiting the shower or bath tub
- During showering and bathing

Erhöhte Sicherheit:

- Beim Ein- und Aussteigen in und aus der Dusch- bzw. Badewanne
- während des Badens und Duschens

Повышенная безопасность:

- во время входа и выхода из душа или ванны
- во время купания или принятия душа

Nagyobb biztonság:

- a zuhany- és fürdőkádból való ki-és belépéskor
- fürdés és zuhanyzás közben



Bathtub trimming options

Möglichkeit des Zuschneiden von Badewannen

Возможности обрезки ванн

Egyedi méretre vágható kádak



Info

Bathtub trimming (ATYS 200x100)

For situations where the architectural properties of bathrooms, especially in the renovation of older buildings, do not allow the installation of classic bathtubs from the regular program, we provide our customers with the possibility of adapting certain bathtubs to their specific requirements. For further information on the models and options, please visit our website www.kolpasan.eu

Zuschneiden von Badewannen (ATYS 200x100)

Für Fälle, in denen die architektonischen Gegebenheiten von Bädern, insbesondere bei älteren Objekten, den Einbau klassischer Badewannen aus dem regulären Programm nicht zulassen, bieten wir unseren Kunden die Möglichkeit an, bestimmte Badewannen an ihre spezifischen Anforderungen anzupassen. Für weitere Informationen über Modelle und Optionen besuchen Sie bitte unsere Website www.kolpasan.eu

Обрезка ванн (ATYS 200x100)

В случае, когда архитектурные особенности ванных комнат (особенно при реконструкции старых зданий) не позволяют установить классические ванны из обычного ассортимента, мы предлагаем нашим клиентам возможность адаптировать определенные ванны к их особым требованиям. Чтобы получить дополнительную информацию о моделях и опциях, посетите наш веб-сайт: www.kolpasan.eu

Kádak méretre vágása (ATYS 200x100)

Amennyiben a fürdőszobák építészeti jellemzői – különösen a régebbi épületek felújításakor – nem teszik lehetővé az alap kínálatban szereplő klasszikus fürdőkádak beépítését, felajánljuk ügyfeleinknek, hogy bizonyos fürdőkádakat egyedi igényeik szerint rendeljenek meg. A modellekkel és opciókkal kapcsolatos további információkért látogasson el weboldalunkra: www.kolpasan.eu

